

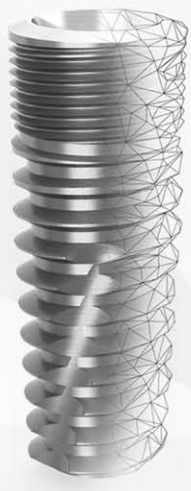

# way

catalog & manual





# Index















5	Key
6	Way implant system
8	Packaging
9	Color code
10	<b>Surgical protocol</b>
10	Preparation of the implant site
15	Removal of implant
16	Implant insertion
18	Tightening of the cover screw
19	<b>Instruments</b>
19	Surgical organizers
24	Surgical planning
24	Drills
33	Implantology equipment
34	Spanners and inserts
42	way Mix
44	way Extra
46	Prosthetic components way Mix and way Extra
56	way Slim
56	Prosthetic components way Slim
60	way Rock
62	way Short
63	Prosthetic components way Rock e way Short
69	<b>Digitals</b>
70	Geadrive
75	Performa
78	<b>Advanced</b>
86	Warnings and sales conditions





# Index

## Material

 Inox	Stainless steel	 PEEK	Polyetheretherketone	 PTFE	Polytetrafluoroethylene
 Al	Aluminium	 PA	Polyamide	 PP	Polypropylene
 WC	Tungsten carbide	 PPSU	Polyphenylsulphone	 PU	Polyurethane
 CoCr	Cobalt chrome	 PMMA	Polymethylmethacrylate	 SI	Silicone
 EVA	Ethylene vinyl acetate	 POM	Polyoxymethylene	 Ti	Titanium
 Au lega	Gold alloy	 PPS	Polyphenylene sulfide		

## Handling instruments

 microsam	 equator	 stepper
---	--	--

## Restorative components

 non rotating	 rotating
--	--

## Abbreviations

<b>H</b>	height	<b>L</b>	length
<b>∅</b>	diameter	<b>p.</b>	platform

The measurements shown in the catalog are expressed in mm.  
The images shown are exclusively representative of the products.

# way

Way is an **implant system designed by Geass** to answer all the professionals' needs, uniting surgical and restorative simplicity and freedom: **five types of implant, specific for every kind of rehabilitation, connected by the same surgical protocol.**

Way guarantees elevated levels of **safety** in all phases of the implant-restoration treatment, as each component is produced respecting the highest quality standards to ensure **precision** and **functionality**.



## ▶ Synthegra surface

Synthegra is the innovative implant surface **patented** by Geass and applied to all the way implants, created to **satisfy two requirements at the same time: to reduce the risk of peri-implant infections and to promote osseointegration.**

Synthegra offers extraordinary results because it has an extremely smooth nature, able to **obstacle bacterial adhesion**, which at the same time acts like a rough surface, **favoring osseointegration.**

Synthegra is the safe and avantgarde answer to **reduce the risk of peri-implantitis** and to achieve the new challenge of **long term osseointegration.**

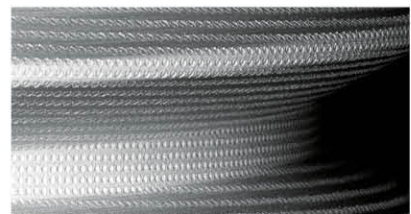
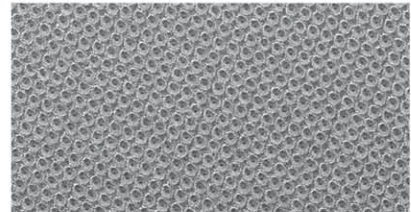

## ▶ Implant Guarantee

A guarantee for reliability that Geass is able to offer **for life on a range of implants and components** thanks to:

- technical **reliability** from **thirty years of know how**;
- clinical reliability from a protocol which has been applied for over 20 years.



## way Mix (p. 42)

The implant which acts on the key factors of the **esthetic result**: maintenance of bone levels, effective conditioning of the soft tissues, creation of an esthetically guided restoration.



## way Extra (p. 44)

Designed for the rehabilitation of **post-extractive** sites with contemporaneous placement of the implant: extra aggressive, extra stable.



## way Slim (p. 56)

The implant with 3 mm diameter, designed for **reduced anatomical** spaces such as the inferior incisors and the upper laterals, not treatable with traditional diameters.



## way Rock (p. 60)

The transmucous implant for the management of the specifics of **distal sectors**, favoring restoration.



## way Short (p. 62)

The implant with a length of 5 and 6.5 mm, specifically for the treatment of cases with **reduced bone height**, avoiding regeneration interventions.



# Packaging

The packaging of the implants is characterized by:

- **blister** in PETG and Tyvek® to guarantee sterility;
- **informative label** placed on the back of the blister
- **sealing sticker** which, as well as guaranteeing that the packaging is not damaged, has a color code for the diameter and length of the implant.



## ► Information label

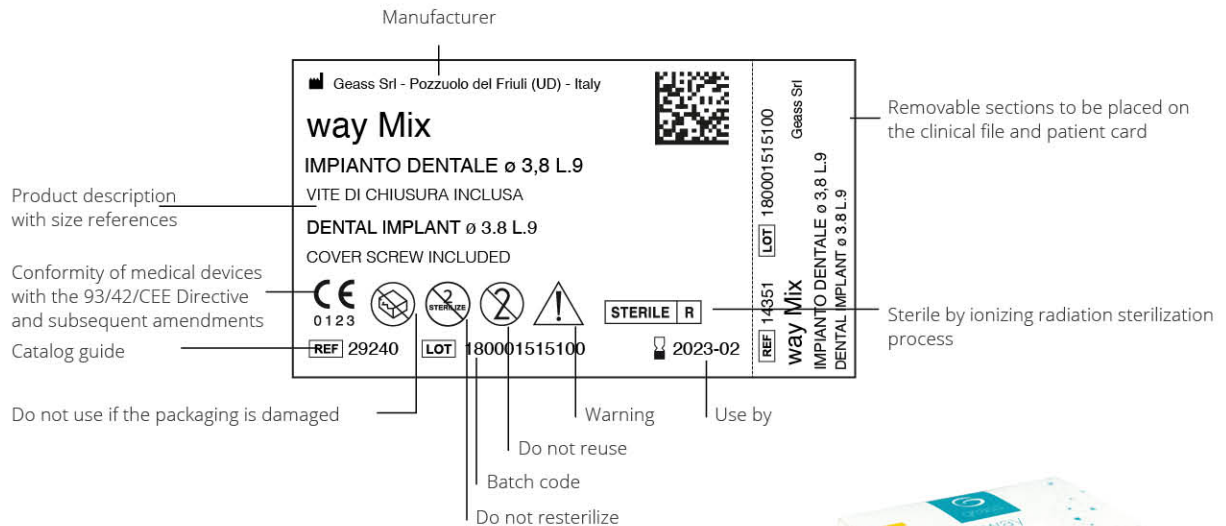

## ► Sterilization

The implants are sterilized with **ionizing radiation** according to the protocol validated based on current regulations. All of the other products are supplied decontaminated in non sterilizable packaging.

# Color code

way|miX

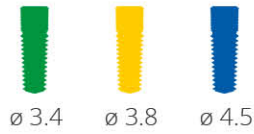

∅ 3.4    ∅ 3.8    ∅ 4.5

way|extra

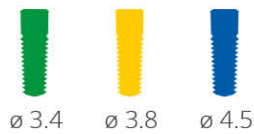

∅ 3.4    ∅ 3.8    ∅ 4.5

way|slim



∅ 3.0

way|rock

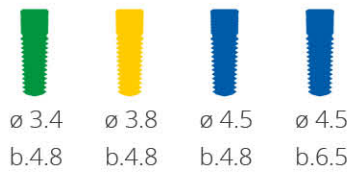

∅ 3.4    ∅ 3.8    ∅ 4.5    ∅ 4.5  
b.4.8    b.4.8    b.4.8    b.6.5

way|short

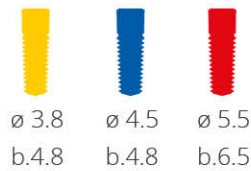

∅ 3.8    ∅ 4.5    ∅ 5.5  
b.4.8    b.4.8    b.6.5

Prosthetic components

unique connection



small profile



large profile

Prosthetic components



p.3.0

Prosthetic components



connection  
p.4.8



connection  
p.6.5

# Preparation of the implant site

The modalities and instruments for the preparation of the implant site are the same for all of the way lines and only depend on the diameter of the implant and the type of bone\*.

**D1** **Dense cortical bone** which requires further widening of the site for some implant lengths. After the standard sequence, the surgical protocol requires the use of a final drill of the same diameter of the implant but shorter, to be sunk until the definitive depth.



**D2-D3** **Dense/porous cortical bone**, with a tight trabecular structure, or thin and porous cortical bone, with a sparse trabecular structure.



**D4\*\*** **Practically non-existent cortical bone**, with a sparse trabecular structure which requires the site to be underprepared. The surgical sequence requires that the last final drill is the shortest available.



\*The classification is the one created by Misch (Bone character: second vital implant criterion, Dent Today 7:39-40,1998), which distinguishes four types of bone density based on the macroscopic characteristics of the cortical and trabecular bone of the edentulous portion to be treated.

\*\* The use of way Slim and way Short implants is not foreseen in cases of D4 bone.

## ► Surgical sequence $\varnothing$ 3



way Slim

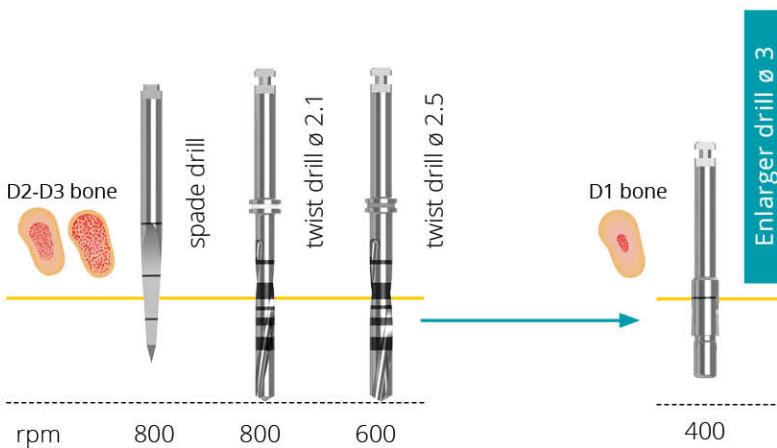

In case of **compact bone**, after the standard sequence widen the perforation with the **enlarger drill**, sinking it up to the mark.



► Surgical sequence  $\varnothing$  3,4

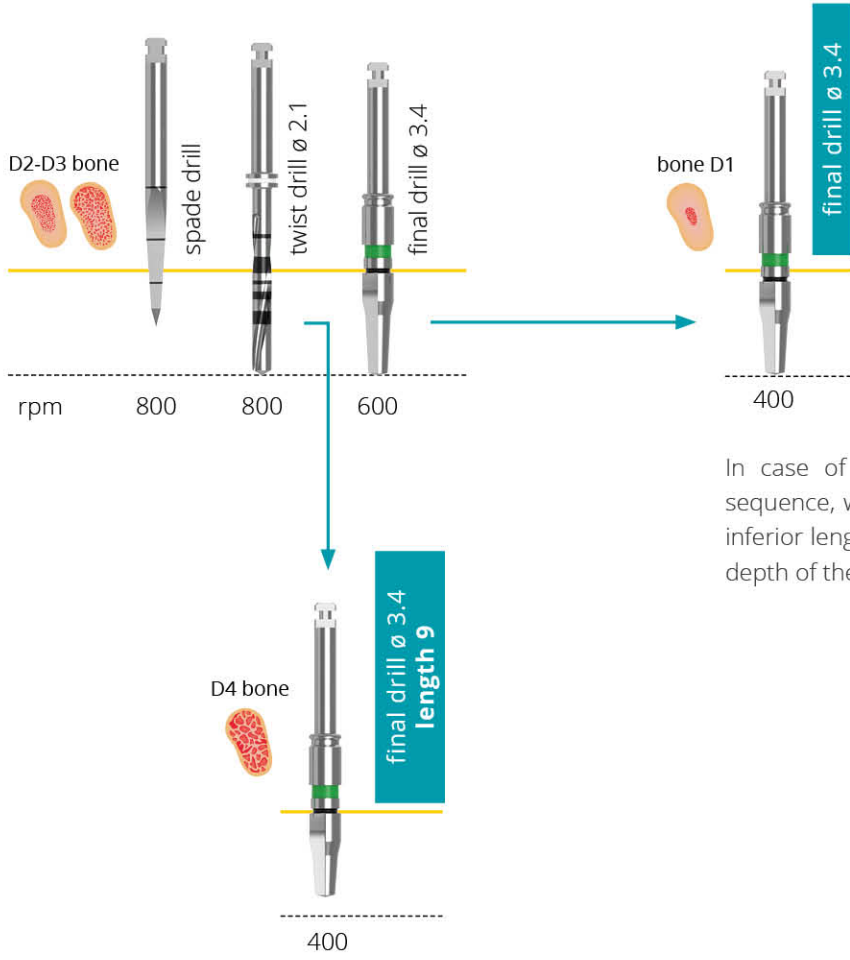

implant length	length last drill	additional depth
10	9	1
11	10	1
12	9	3
13	10	3
15	12	3

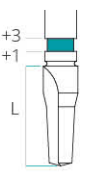

In case of **compact bone**, after the standard sequence, widen the hole with a **final drill 3.4** of inferior length (see table), sinking it up to the final depth of the site.

In case of **bone D4**, after the twist drill 2.1 the last step foresees to use the **final drill 3.4 L. 9 mm**, whatever the implant length is.

## ► Surgical sequence $\varnothing$ 3,8

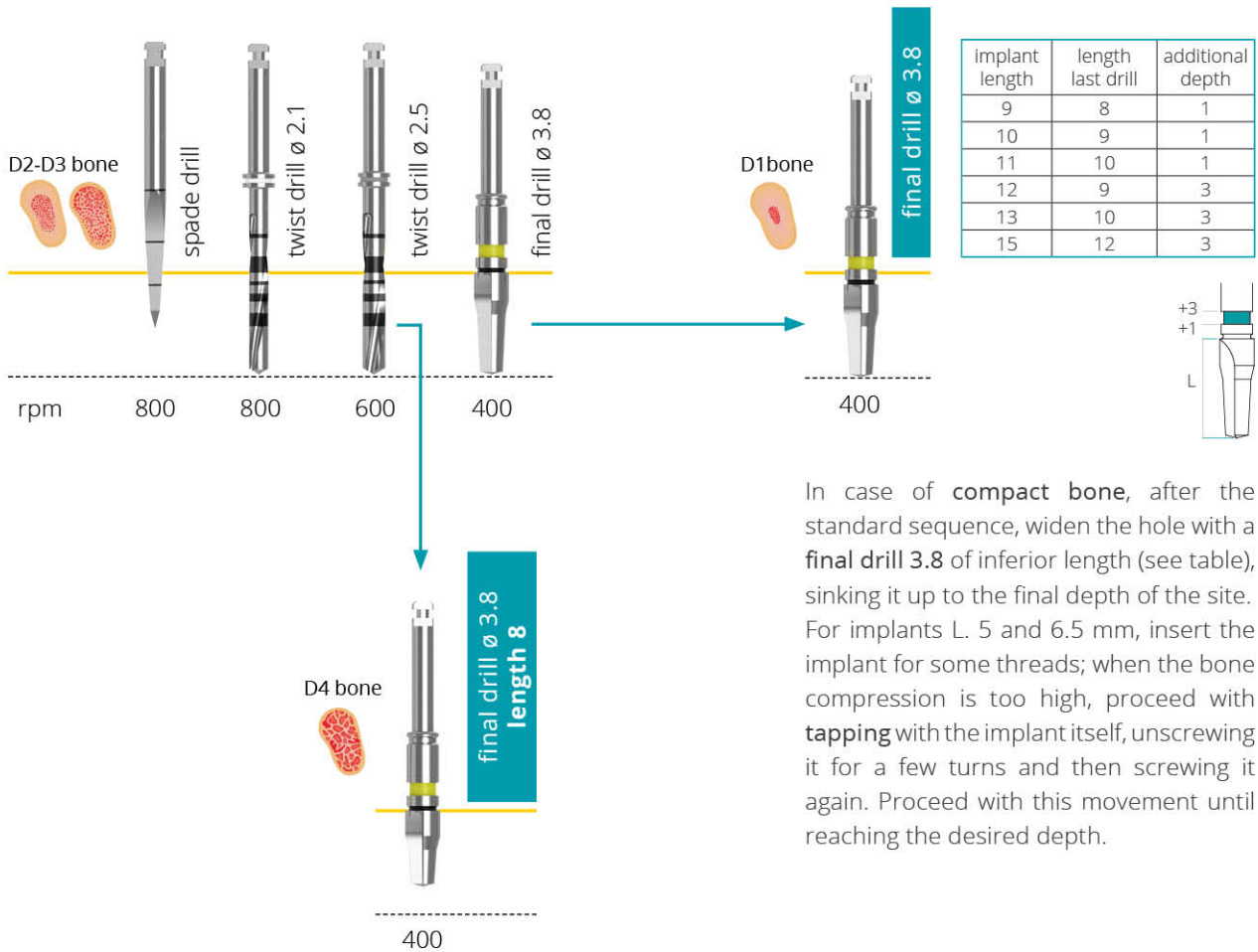

In case of **compact bone**, after the standard sequence, widen the hole with a **final drill 3.8** of inferior length (see table), sinking it up to the final depth of the site. For implants L. 5 and 6.5 mm, insert the implant for some threads; when the bone compression is too high, proceed with **tapping** with the implant itself, unscrewing it for a few turns and then screwing it again. Proceed with this movement until reaching the desired depth.

In case of **bone D4**, after the twist drill 2.5 the last step foresees the use of the **final drill 3.8 L. 8 mm**, whatever the implant length is



► Surgical sequence  $\varnothing$  3,4

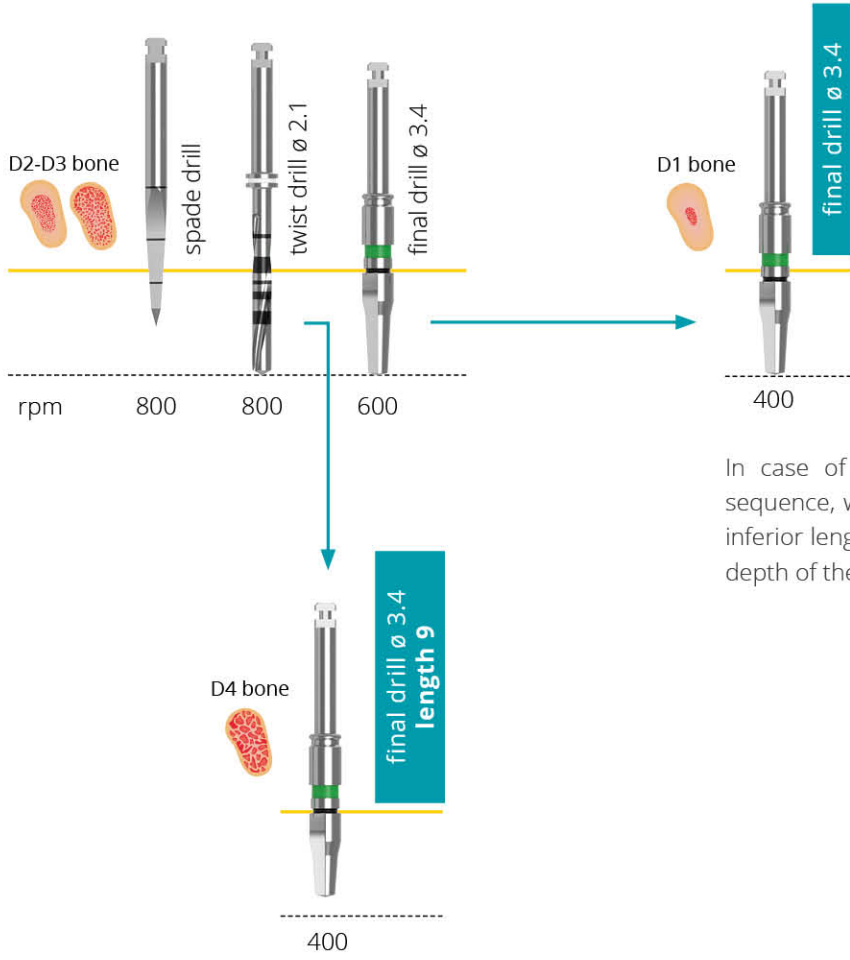

implant length	length last drill	additional depth
10	9	1
11	10	1
12	9	3
13	10	3
15	12	3

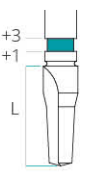

In case of **compact bone**, after the standard sequence, widen the hole with a **final drill 3.4** of inferior length (see table), sinking it up to the final depth of the site.

In case of **bone D4**, after the twist drill 2.1 the last step foresees to use the **final drill 3.4 L. 9 mm**, whatever the implant length is.

► Surgical sequence  $\varnothing$  5.5



way Short

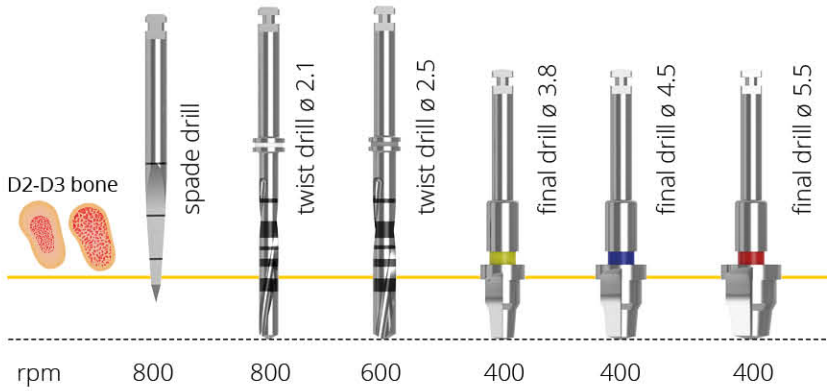

**D1 bone**  In case of compact bone insert the implant for some threads; when the bone compression is too high, proceed with **tapping** with the implant itself, unscrewing for a few turns and then screwing it again. Continue with this movement until the desired depth.

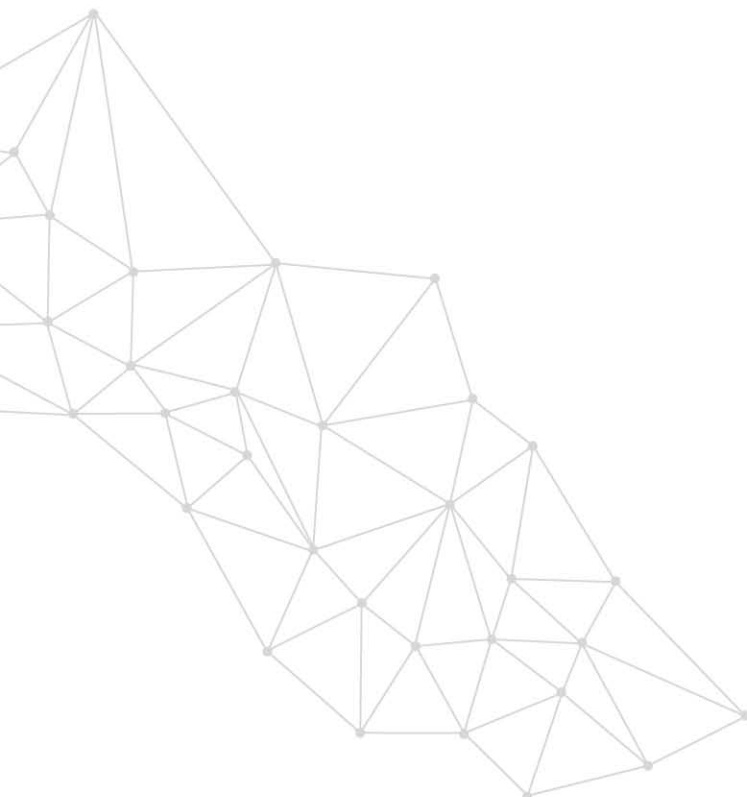

# Removal of implant

## ► Touch&go

The touch&go functional solution is an innovative system which allows for the **removal of the implant in a rapid and sure** fashion without compromising its sterility. Its special ergonomics allows you to block the implant in place, facilitating coupling between the implant seat and the insert.



Before **opening the implant packaging**, check on the label on its back that the diameter and length measurements of the implant are suitable to the intervention. Opening of the blister must be carried out according to the clinician's own procedure to **maintain sterility**.



Keep touch&go in a vertical position and remove the upper part which contains the cover screw.



Press the **extruding parts** so that the two titanium sheets move towards each other, always keeping touch&go in a vertical position; in this way the implant is stable.

With the other hand, **introduce the driver or the insert** in the implant seat and match the two devices, slightly.

Reduce the pressure on touch&go and **remove the implant**.



**Remove the cover screw** contained in the upper body of the touch&go using the driver or Microesam terminal.



# Implant insertion



## Manual insertion

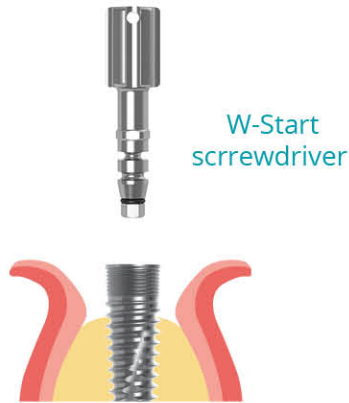

Remove the implant from the touch&go holder using the W-Start screwdriver, identifiable by the presence of the **o-ring**. Insert the implant for a few threads into the implant site.

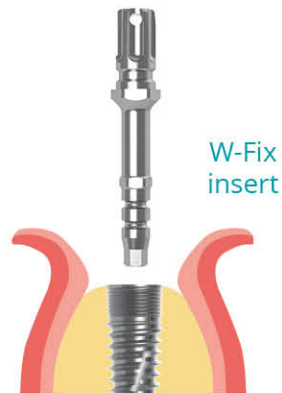

**Complete** the insertion of the implant **at crest level**, using the ratchet wrench with the W-Fix insert. do not exceed the **torque of 50 Ncm**. Verify through the hexagons of the inserts that the **orientation** of the implant seat promotes the correct use of abutments.

## Insertion with micromotor

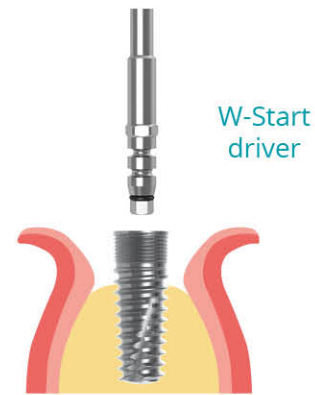

Remove the implant from the touch&go holder using the W-Start driver, identifiable by the presence of the o-ring. Insert the implant, keeping below **15 rpm**; do not exceed the torque of **50 Ncm**.

Way Extra is indicated exclusively for rehabilitations which foresee the insertion of the implant at the same time as dental extraction (post extractive sites). In these clinical situations, it is necessary to take some other aspects into consideration:

- it is necessary to confirm the **presence of 3-4 mm** of native bone apically to the alveolar, essentially for the retention of the implant;
- to achieve excellent esthetic results, it is recommended that you position the implant **1 to 3 mm below the crestal margin**;
- the way Extra implant makes it possible to slightly modify the insertion axes during placement, in order to achieve an excellent prosthetic orientation.

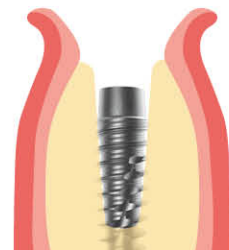



way Rock way Short

## Manual insertion

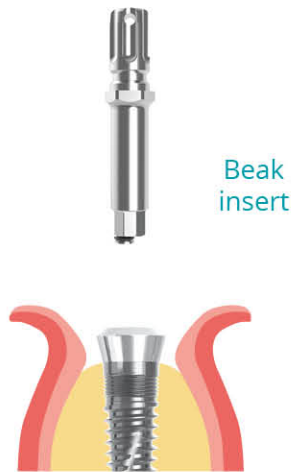

Remove the implant from the touch&go holder, using the Beak insert.  
Do not exceed the torque of **50 Ncm**. Insert it in the implant seat and **complete the placement of the implant**, so that the laser treated portion is completely inserted in the bone tissue.

## Insertion with micromotor

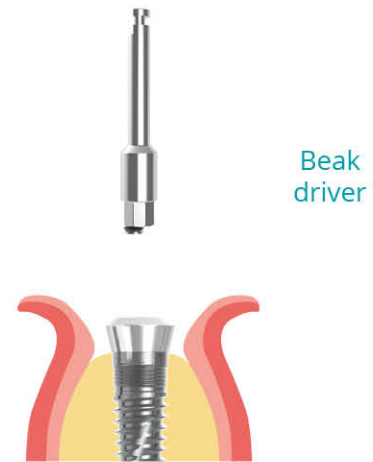

Remove the implant from the touch&go holder using the Beak driver.  
Insert the implant, keeping below **15 rpm**; do not exceed the torque of **50 N•cm**.

## Tightening of the cover screw

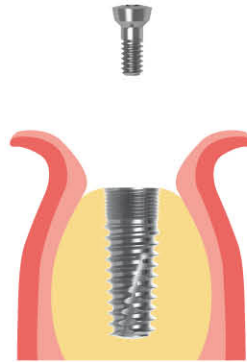
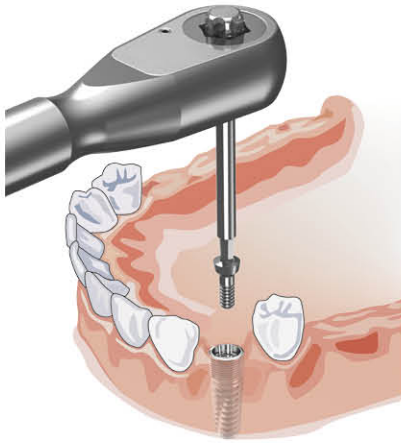

Remove the cover screw from the upper part of the touch&go holder, using a spanner with the Microsam tip. After having cleaned the implant seat, tighten the cover screw, with a maximum torque of 15 Ncm.



# Surgical organizers

## way organizer

*instruments not included* 31351

PPSU SI

All instruments of way lines, including way Slim and way Short, are hosted in a unique tray, organized according to a logical and intuitive path.

Main characteristics:

- **functional:** thanks to the hinged lid, it is possible to incline it and to easily take the instruments;
- **rational:** in the tray there are the rotary instruments and the inserts; on bottom of the tray, the wrenches are accommodated;
- **safe:** once closed, the tray remains blocked to avoid any movement of the instruments;
- steam sterilisable up to 134°C

Supplied with x-ray template.



Arrangement of instruments inside way organizer

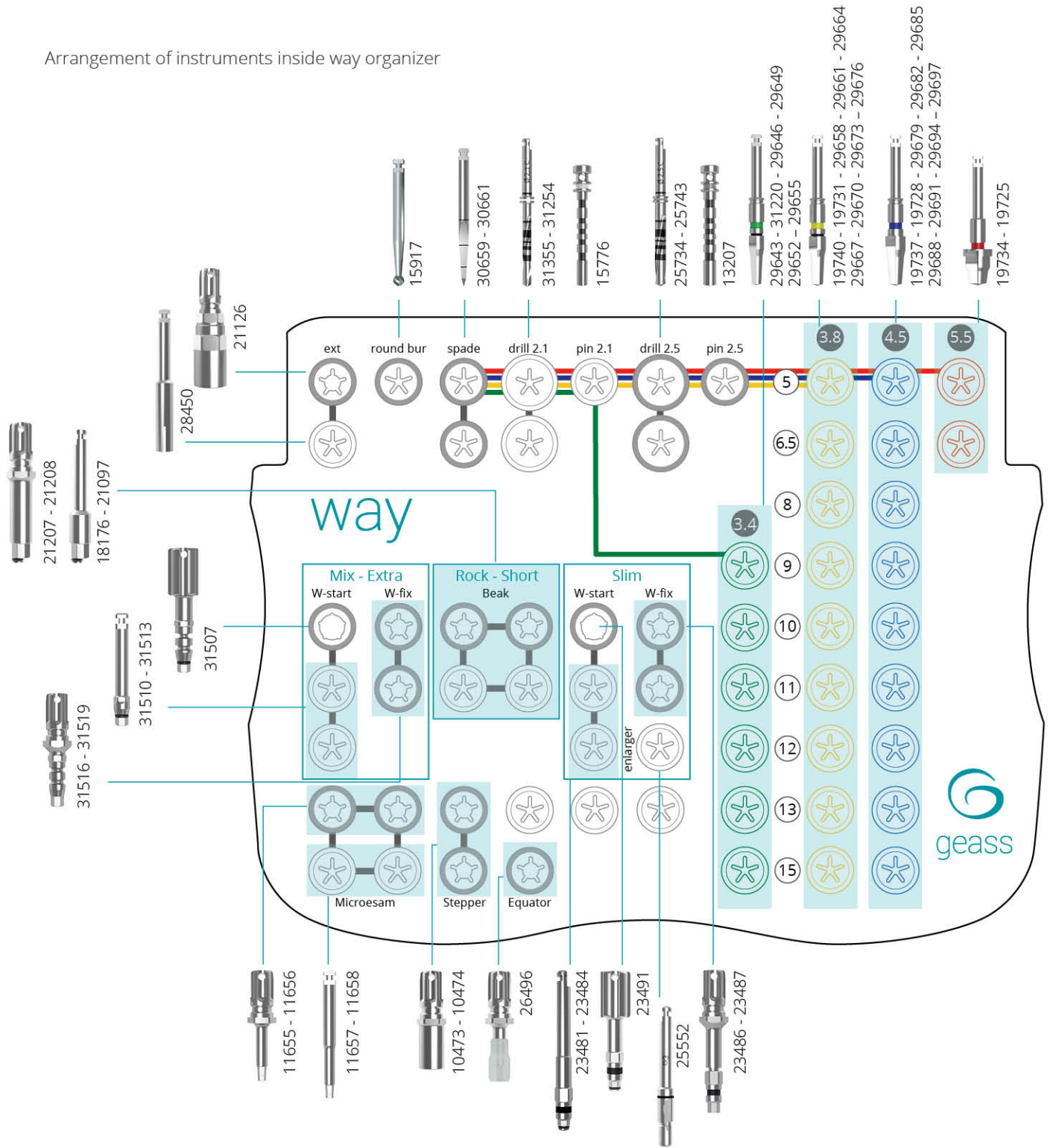



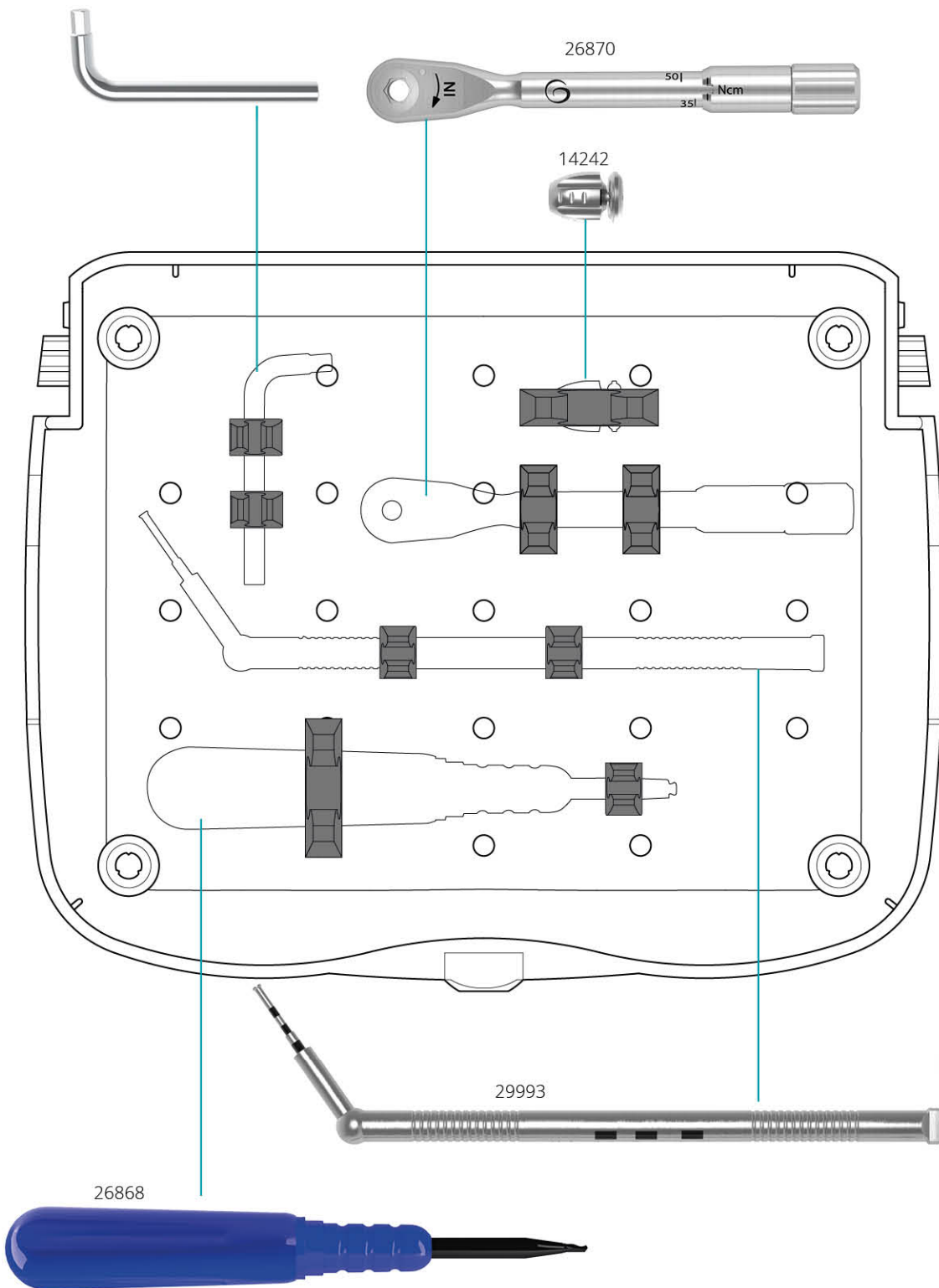

## way Slim organizer

In a single organizer, all of the surgical and restorative instruments for way Slim implants. Supplied with x-ray template.

*instruments not included* 30665

PPSU

SI

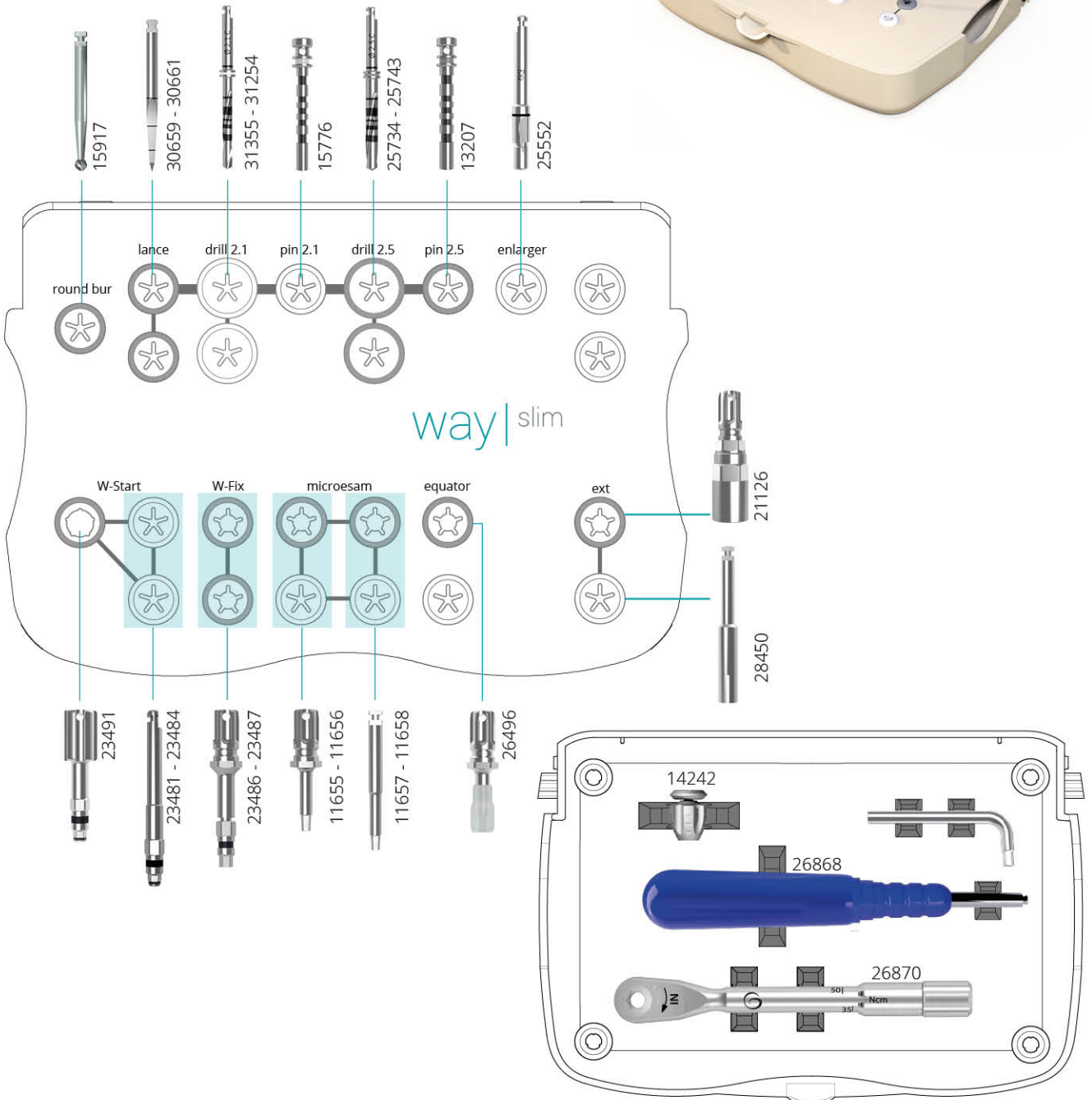

## way Short organizer

In a single organizer, all of the surgical and restorative instruments for way Short implants. Supplied with x-ray template.

*instruments not included* 30663

PPSU SI

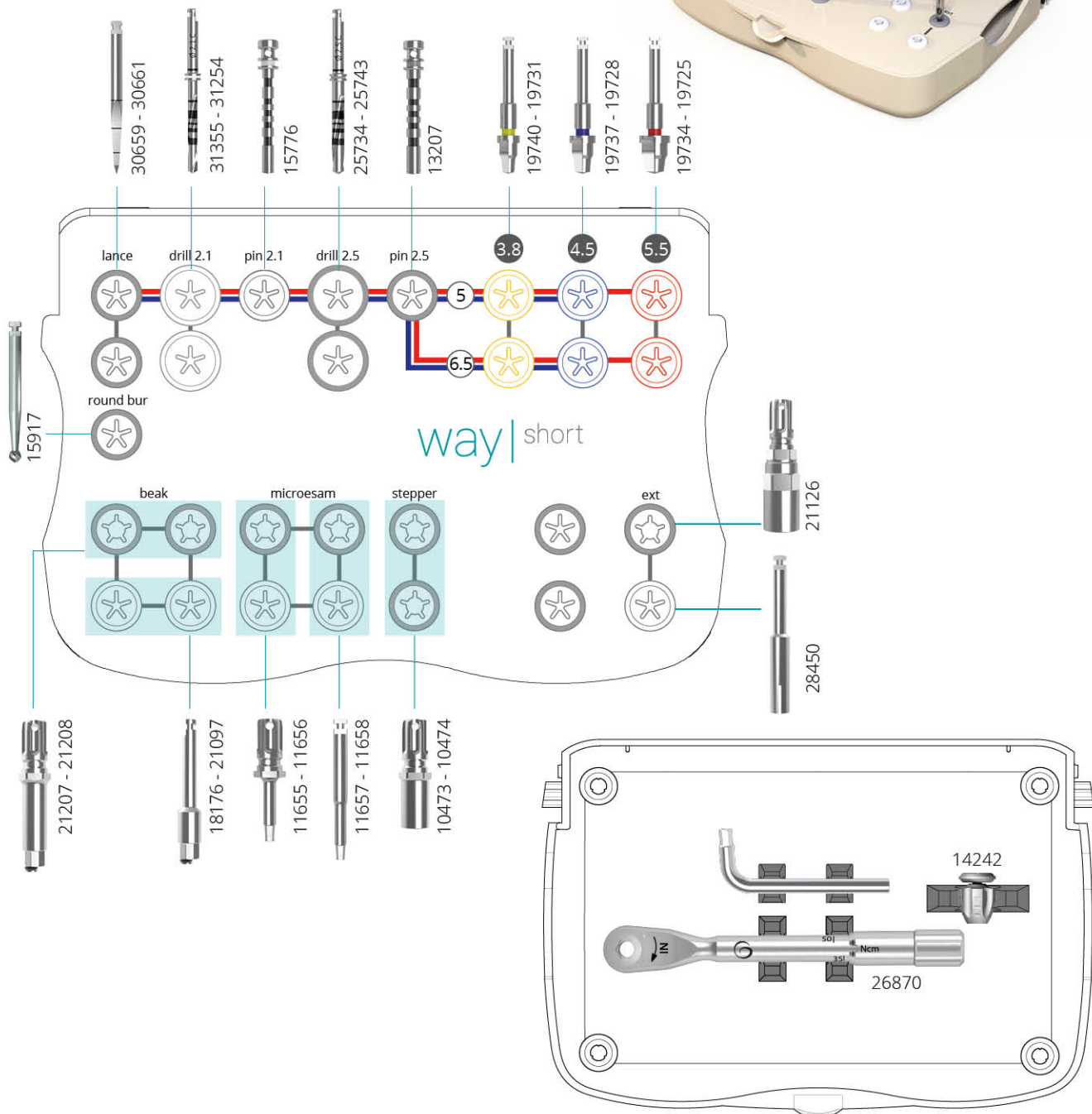

# Surgical planning

## X-ray template

way Mix and way Rock	19054
way Extra	19053
way Slim	19465
way Short	20599

It shows all the implant sizes, according to the following scales:  
 1:1 Computerized Tomography (CT); 1,1:1 Endoral radiography  
 1,25:1 Orthopantomogram (OPG)

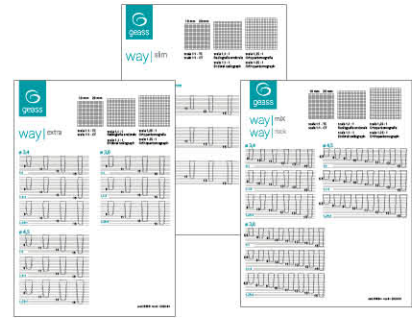

## Depth probe

	29993
--	-------

Ti

Ideal instrument to verify the depth of the osteotomy; the various sizes are also reported on the shank to facilitate the reading.

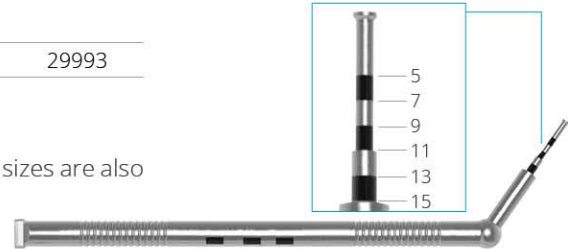

## Drills

The **visual references** present on the drills allow you to evaluate the depth drilled based on the length of the implant chosen.

The drilling phases must be carried out with **an up and down movement, without exceeding the maximum speed indicated** in each phase of the protocol. The use of the Drill Controller for the twist drills and the Stop for the final drills facilitates the perforation.

**Do not use drills which result as damaged, are not sharp or which have been used for more than 4 applications** in order to reduce risks of overheating and bone trauma which may compromise the osseointegration process.

## Drill extension

	28450
--	-------

Inox

To be used with rotating instruments in order to easily reach the intervention regions between two dental elements.



## Round bur

	15917
--	-------

Inox

WC

To be used as an alternative to the lance drill or to level any small unevenness on the bone crest.



## Spade drill

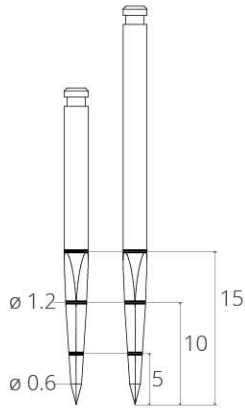

short	30659
long	30661

Inox

This creates a **niche on the cortical bone** for the subsequent drills. It creates a **precise entrance point** thanks to its perfect centering

- ! Do not sink the instrument up to the final length of the implant to be inserted; use the reference notches to always maintain a margin of at least 2 mm between the depth of the drill and that of the implant site.



## Indicator pin

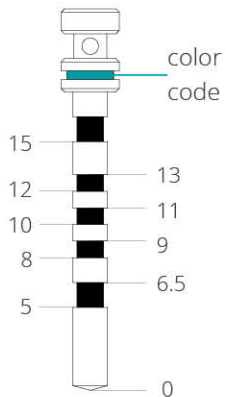

ø 2.1	□	15776
ø 2.5	■	13207

Ti PU

Inserted into the implant site being created, it **indicates axis and depth** thanks to the notch, as shown in the side diagram.



## Enlarger drill ø 3

25552
-------

Inox

To be used for **way Slim implants in case of D1 bone**; it should be sunk up to the mark, regardless of the implant length.





### Twist drill

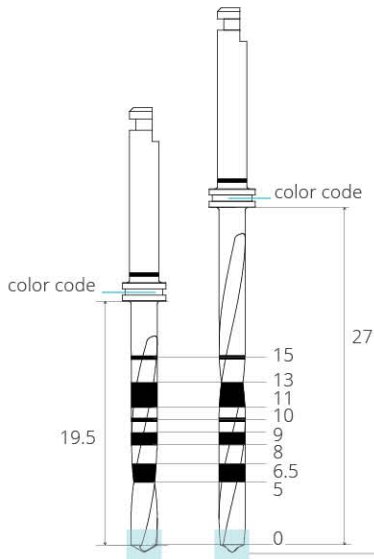

□	∅ 2.1	short	31355
□	∅ 2.1	long	31254
■	∅ 2.5	short	31357
■	∅ 2.5	long	31256

Inox



This prepares the implant site based on the length of the chosen implant. The measurements indicated by the notches do not include the tip of the drill, about 0.7 mm. It is therefore advisable to consider this difference when planning the perforation phases. The drills are to be matched only with the dedicated stops, shown in the current catalogue; do not use other stops, as an implant site with wrong dimensions could thus be created, with serious risks for the patient.

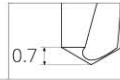

### Final drill

	5	6.5	8	9	10	11	12	13	15
■				29643	31220	29646	29649	29652	29655
■	19740	19731	29658	29661	29664	29667	29670	29673	29676
■	19737	19728	29679	29682	29685	29688	29691	29694	29697
■	19734	19725							

Inox



It allows you to complete the implant site with widening suitable for the dimensions of the implant.

The nominal depth of the drill (tip included) corresponds with the notch where the working part of the drill finishes.

The inferior limit of the coloured band corresponds to a depth increase of 1 mm; the upper limit corresponds to a depth increase of 3 mm.

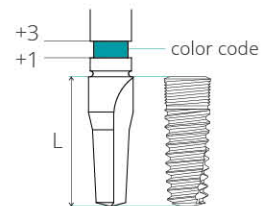

The final drills L.5 and 6.5 mm come equipped with integrated drill stop, beyond which you must not descend.

On one side the stop has been milled with a longer cutting edge making it possible to level the bone crest.

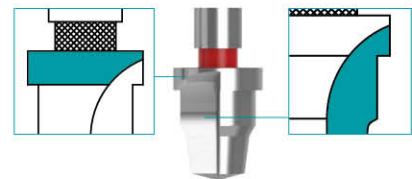

## Drill controller

It contains stops for the twist drill, for which it facilitates the insertion, and stops for the final drill, allowing easy removal.

The lid provides a millimetric graded scale, to be always used to verify that the working part of the drill is of the correct length.

stops not included 31549

PPSU PP

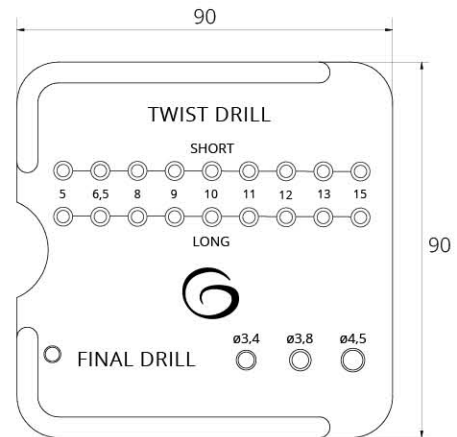

## Stop for twist drill



	Implant length								
	5	6.5	8	9	10	11	12	13	15
short drill	31259	31262	31265	31268	31271	31274	31277	31280	31283



	Implant length								
	5	6.5	8	9	10	11	12	13	15
long drill	31286	31289	31292	31295	31298	31301	31304	31307	31310



Designed to reach the **planned depth** with the twist drills in a precise, safe and controlled manner, safeguarding the anatomical respect zones. Stops dedicated to long drills are distinguished by letter "L".

- ! They must be exclusively used with the twist drills shown on the current catalogue, otherwise serious risks can be caused to the patient



## ► Protocol of use

Having fixed the drill to the handpiece, insert it in the drill controller, selecting the stop on the basis of the length of the implant to be inserted.

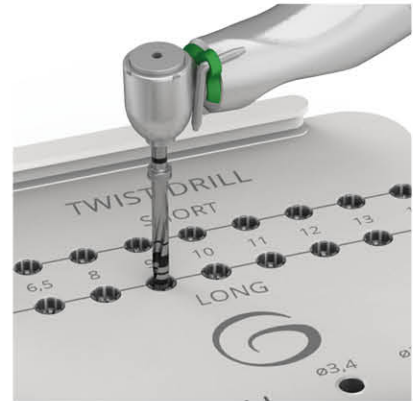

Push the drill into the stop until it is fully inserted. Once insertion has been carried out, remove the drill. Verify that the stop inserted is the correct one, using the references printed on the lid of the drill controller; the length of the working part of the drill must correspond to that of the implant chosen.



Carry out the perforation in the bone tissue, pushing the drill until the stop strikes the cortical bone.

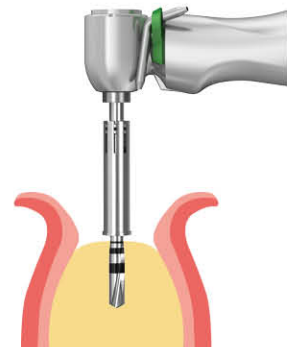

Once finished the perforation, remove the stop, with attention to the cutting edge of the drill.



## Stop for final drill

	16549
	10953
	10954

 Inox

It makes it possible to control the perforation depth during the **last phase of drilling**, reducing risks to the anatomical respect zones.

The final drill stops must not be used with 5 and 6.5 mm drills as the stop is integrated into the drill itself.



## ► Protocol of use

Insert the stop on the drill from above, following the indicated direction. Fix the drill to the handpiece. Press the device in the part indicated by the arrows and push until it clicks into position.

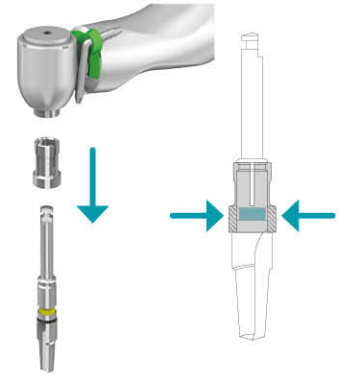

Carry out the perforation in the bone tissue, pushing the drill until the stop strikes the cortical bone.

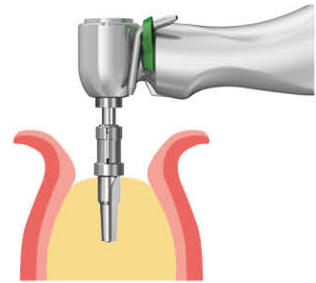

When the use is completed, insert again the drill (still fixed to the handpiece) in the drill controller, in the specific hole corresponding to the diameter of the stop.



Press the drill downwards; the groove inside the hole allows you to release the stop.

Remove the drill from the handpiece and consequently the stop.

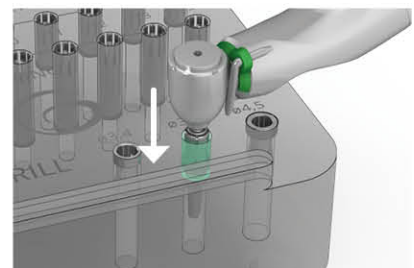

## Bone Profiler organizer

It hosts all the instruments Bone Profiler, besides the spanners and inserts necessary to the restoration with Mua abutments, thus avoiding to sterilise the complete surgical kit.

	31541
--	-------

PPSU SI

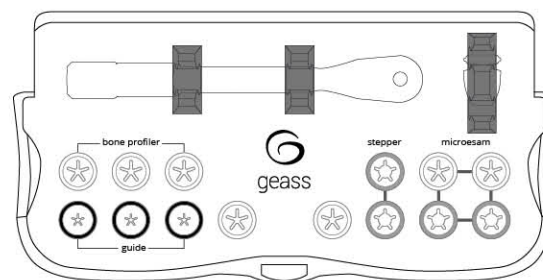

## Bone Profiler

H 1	30720
H 3	30722

Inox

It allows to level the bone crest, thus creating the necessary space to correctly place the Mua abutment.

It must be used **in combination with the guide**, into which it must be correctly inserted, before being started. Maximum speed of use: 200 rpm. Choose the instrument, based on the height of the Mua abutment to be used.



## Bone Profiler guide

	30727
--	-------

Ti



It keeps the bone profiler in the correct axis during its use, thus protecting the implant connection. Before using the bone profiler, screw the guide into the implant, tightening it with the Microsam instruments at 15 Ncm.

## Protocol of Bone Profiler

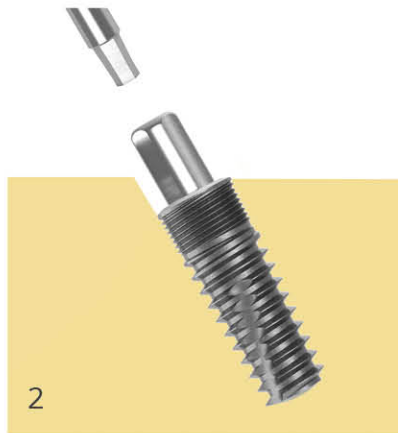
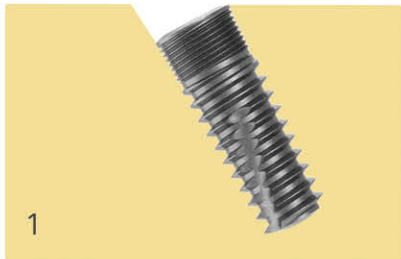

After placement of the implant, tighten the **guide** for bone profiler into the implant seat with the Microsam instruments at 15 Ncm.

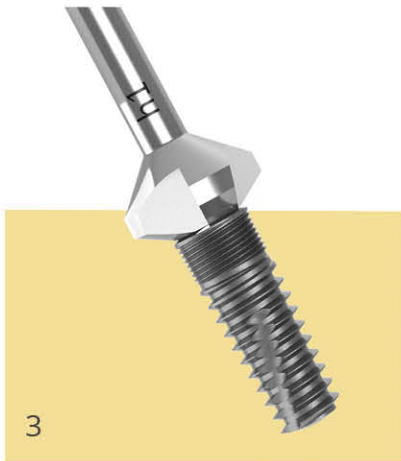

Choose the correct bone profiler, based on the height of the Mua abutment. Insert the bone profiler into the guide and, **only after positioning**, start it at the maximum speed of 200 rpm.

In case of an implant placement particularly under the crest, pay attention to the soft tissues; if necessary, open a flap to avoid damage.

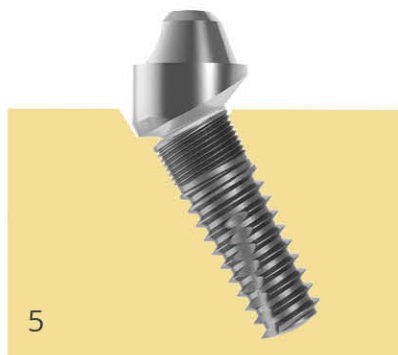
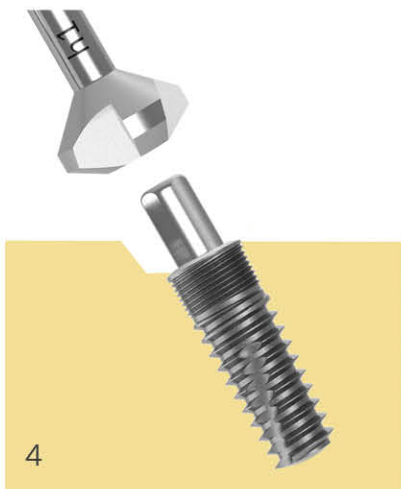

After having leveled the bone crest, remove the guide and place the **Mua** abutment.

# Equipment for implantology

Thanks to a detailed design, **safety** of use and high level **materials**, the W&H equipment satisfies the required standards, thus guaranteeing maximum **precision** in oral surgery.

The **Implantmed** motors guarantee high reliability; the **contra angles** are characterized by strength and effective ergonomics.

For those who use the ultrasound technology, **Piezomed** ensures maximum precision, without damaging the soft tissues.

Thanks to **Osstell Beacon**, it is easy and fast to verify osseointegration and implant stability.



# Spanners and inserts



To be used for handling the implants and prosthetic components.

All **inserts** can be used **alone or in combination with the screwdriver, the ratchet wrench or the torque wrench**; in the latter cases, verify that the matching between the two devices is correct.

The **drivers** are to be inserted on the handpiece to handle the various devices easily and quickly; ensure that they are effectively retained. A maximum speed of 15rpm is advisable.

For the **tightening of the prosthetic components**, always use a controlled torque wrench, as the use of the screwdriver or of the ratchet wrench can easily lead to excessive torque. When using spanners and inserts, it is important **to avoid lateral bendings**, which may cause the instrument break or the damage of the handled components.

## Screwdriver



		14242
<i>o-ring</i>	<i>pack 3pcs</i>	21143
		

It allows you to use the **various inserts manually**, giving you the utmost perception and sensitivity in your handling.

You will feel a **click** when the insert connects with the screwdriver, indicating that insertion has taken place correctly.



## Universal screwdriver



		28641
<i>o-ring</i>	<i>pack 3pcs</i>	21143
		

Matched with the inserts, it allows an easy handling during the implant insertion, thus guaranteeing an excellent control of direction.

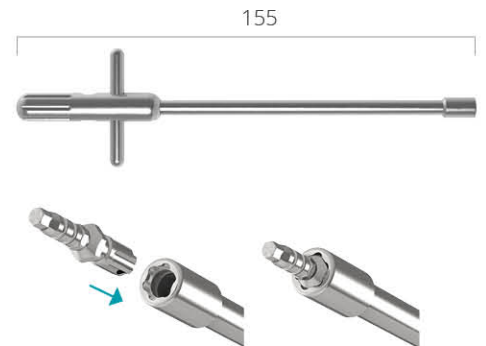
Due to the high torque values it can easily reach, it must **not be used for the tightening of the prosthetic components**.



## Insert extension

		21126
<i>o-ring</i>	<i>pack 3pcs</i>	21144
		

To be used with the inserts in order to easily reach the intervention region between **two dental elements**.

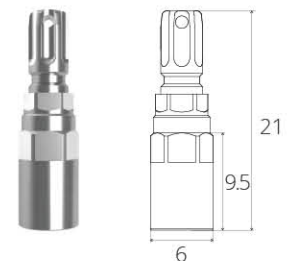



## Newton screwdriver

		26870
<i>lubricant</i>		17002
<i>o-ring</i>	<i>pack 3pcs</i>	21143

Inox

PTFE

PPS

Coupled with the inserts, it is used to screw and unscrew the various devices easily and quickly, according to two modes: ratchet (no predefined torque limit) or dynamometric (calibrated torque).

Once the suitable insert has been selected, insert it into the head of the wrench and verify that the hexagonal profiles of the two devices are properly coupled. Rotate it until the hexagonal profiles of the two devices are coupled and push the insert downwards.

The arrow 'IN' on the wrench head shows the position of the wrench when tightening; by turning the device over, the arrow "OUT" is used when loosening screws. Pay attention to the position of the wrench during use, so that the rotation axis coincides with the axis of the handled device.

To select the torque limit, rotate the handle until the desired value; the adjustment key supplied in the package allows you to switch faster from one value to the other.

The selection of the torque must always be performed, during screwing of the handle clockwise; therefore, in order to adjust to an inferior torque to that set, it is important to unscrew the handle by two turns under the desired torque value, then screw again to the required value.

### Tightening in torque mode

To tighten with a pre-set value of torque, rotate the handle until it is positioned exactly in line with the required value, then move the wrench in the direction indicated by the arrow; once the torque value has been reached, the wrench spins freely.

### Tightening in ratchet mode

To use the wrench without a pre-set value of torque, rotate the handle until the writing "R".

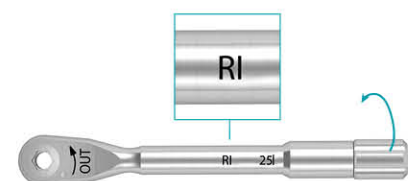
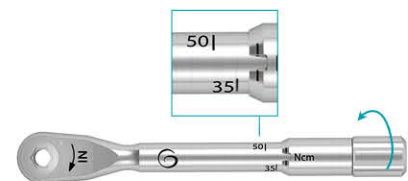

# Implant placement

## ► way Mix and way Extra

### W-Start screwdriver

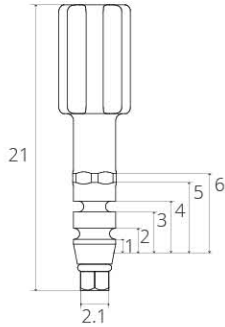

	31507
<i>o-ring</i>	19034



To remove the implant from touch&go holder and insert it for some threads into the implant site manually. It differs from the W-Fix insert for the presence of the **o-ring** and for the fact that it cannot be used with the Newton torque wrench.



### W-Start driver

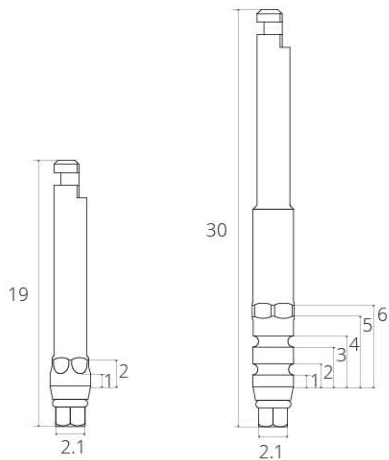

short	31510
long	31513
<i>o-ring</i>	19034



To remove the implant from touch&go holder and insert it for some threads into the implant site with the micromotor.



### W-Fix insert

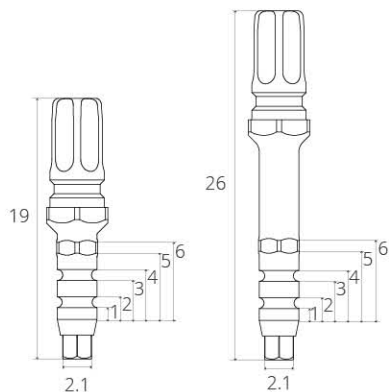

short	31516
long	31519



To complete the implant insertion into the implant site, together with the Newton torque wrench.





► **way Slim** The instruments for way Slim are characterized by a black notch.

### W-Start screwdriver $\varnothing 3$

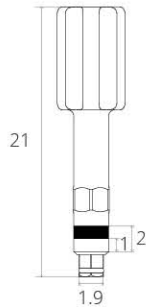

	23491
<i>o-ring</i>	23485



To remove the implant from touch&go holder and insert it for some threads into the implant site manually. It differs from the W-fix insert for the presence of the o-ring and for the fact that it cannot be used with the Newton torque wrench.



### W-Start driver $\varnothing 3$

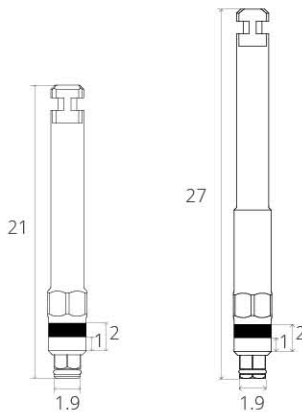

short	23481
long	23484
<i>o-ring</i>	23485



To remove the implant from touch&go holder and insert it for some threads into the implant site with the micromotor.



### W-Fix insert $\varnothing 3$

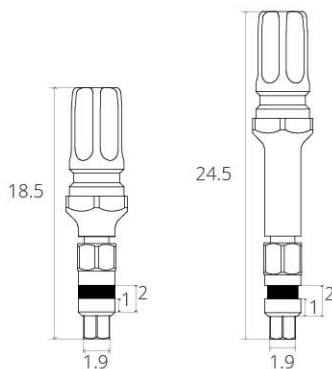

short	23486
long	23487



To complete the implant insertion into the implant site, together with the Newton torque wrench.



## ► way Rock and way Short

### Beak insert

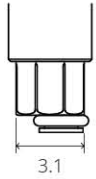

short	21207
long	21208
<i>o-ring</i>	23025



To remove the implant from touch&go holder and insert it for some threads into the implant site



### Beak driver

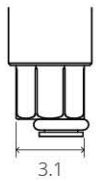

short	21209
long	21097
<i>o-ring</i>	23025



To remove the implant from touch&go holder and insert it into the implant site with the micromotor.



# Tightening prosthetic components

## Microesam insert

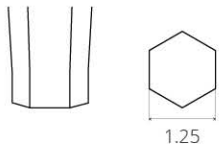

short	11655
long	11656



To be also used with the **majority of the prosthetic components** of way implants.



## Microesam driver

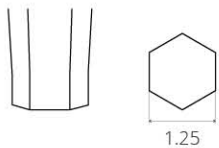

short	11657
long	11658



To be also used with the **majority of the prosthetic components** of way implants.

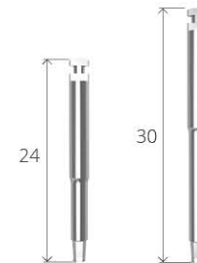

## Stepper insert

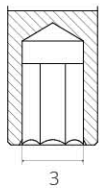

short	10473
long	10474



To handle the **Mua straight abutment** (way Mix) and the **Reflect abutment** (way Rock).



## Equator insert

	26496
<i>holder (replacement)</i>	26497



To handle the **Equator abutments**.



## Insertion-extractor tool Equator

	26868
--	-------



To insert and remove the caps of the Equator system. Autoclavable.

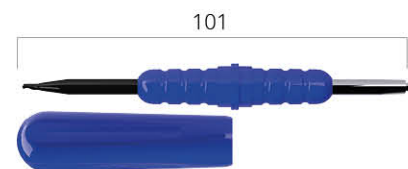

# Synthegra

## doubly unique, doubly effective

From Italian research performed by Geass, Synthegra is the safe answer and at the forefront against peri-implantitis, rising up to the new challenge of long term osseointegration.

Synthegra is the only implant surface treated by laser which can boast:

1

- an extremely smooth nature
- lesser bacterial adhesion



less risk of peri-implant infection

2

- greater adhesion of the fibrin
- greater contact osteogenesis



perfect osseointegration

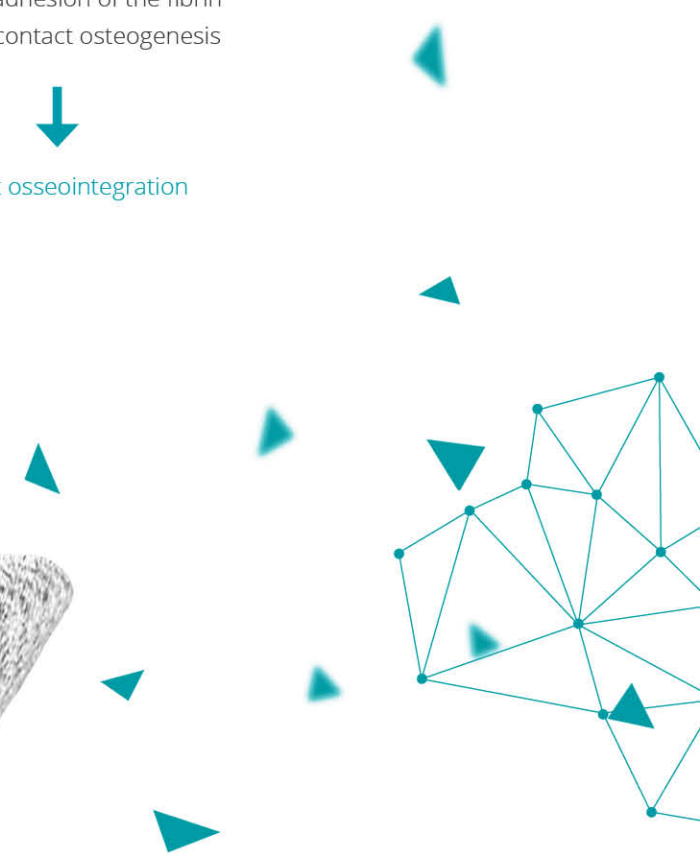
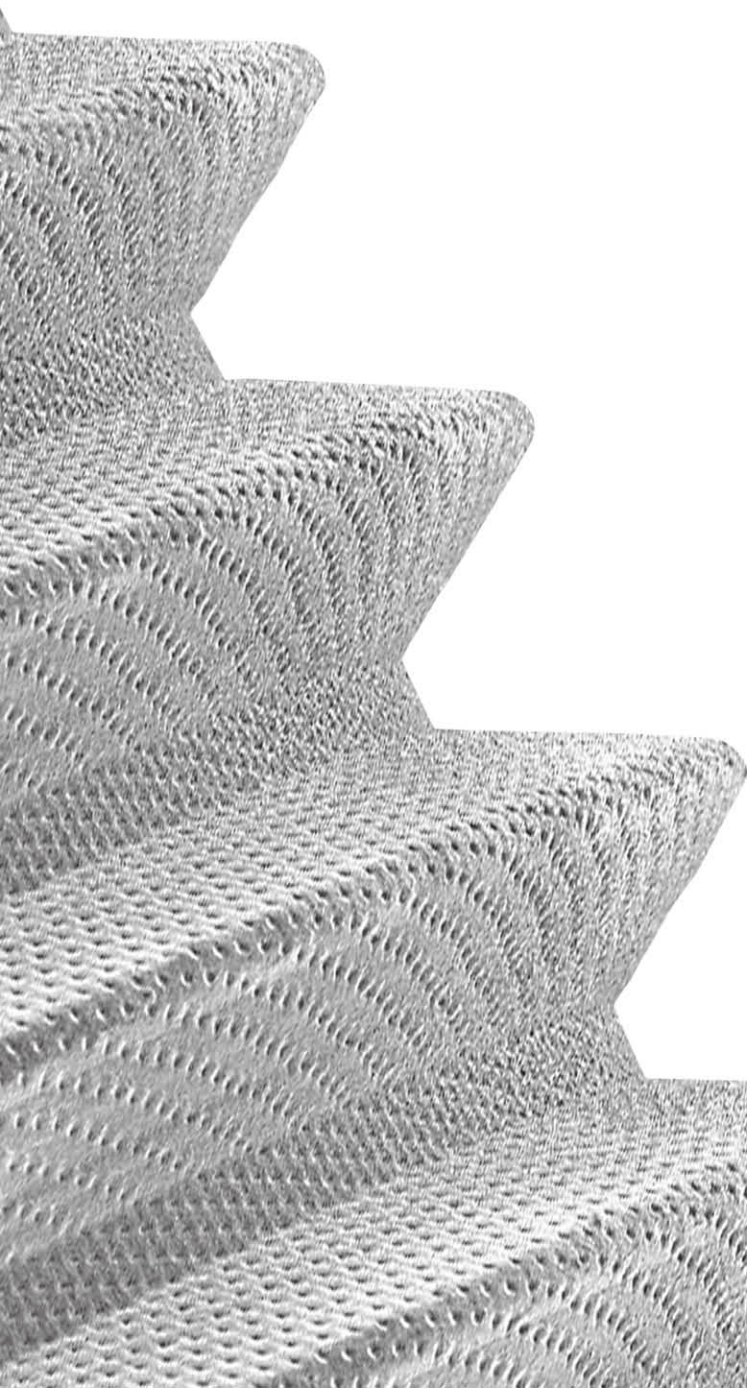

way|slim



way|mix



way|extra





# way | miX

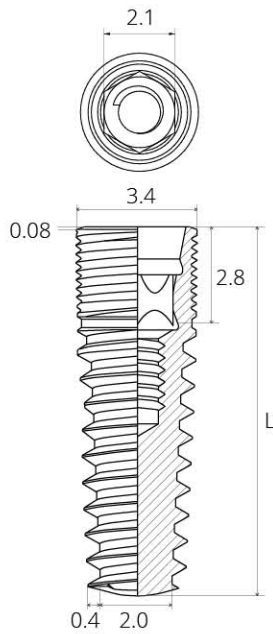

Ø 3.4



L	
9	29216
10	31217
11	29219
12	29222
13	29225
15	29228

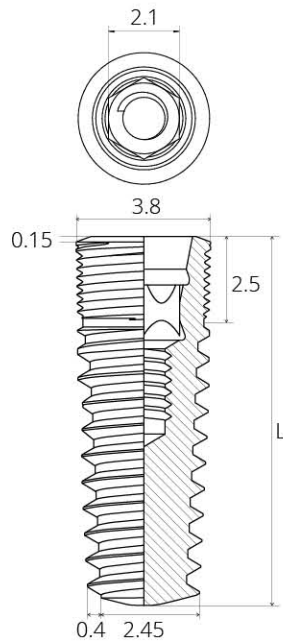
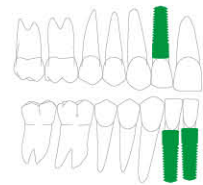

Ø 3.8



L	
6,5	31223
8	29231
9	29234
10	29237
11	29240
12	29243
13	29246
15	29249

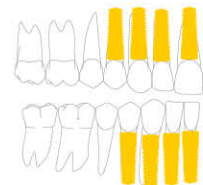

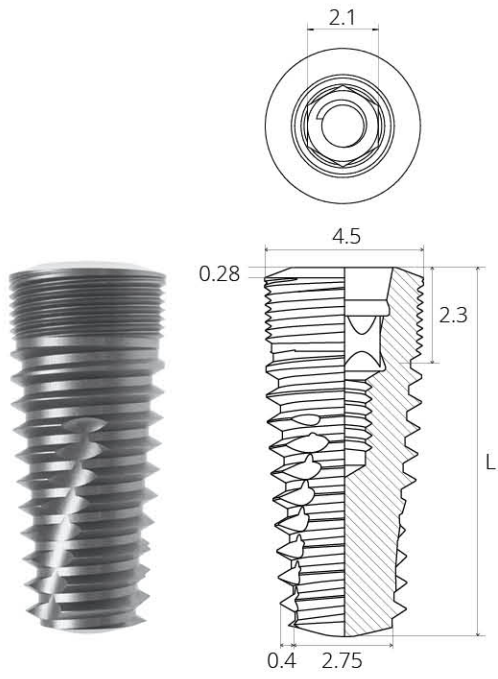

Ø 4.5	
L	
6,5	31226
8	29252
9	29255
10	29258
11	29261
12	29264
13	29267
15	29270

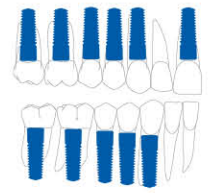



# way | extra

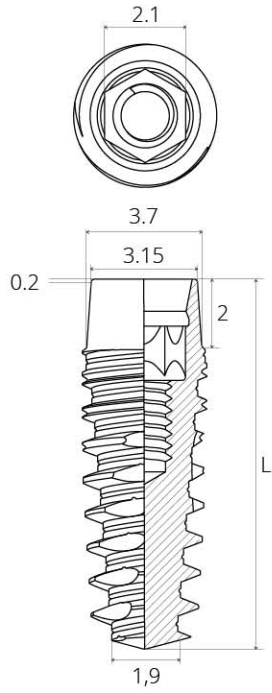

<b>∅ 3.4</b>
L
9 27281
11 27283
13 27285
15 27287



Ti

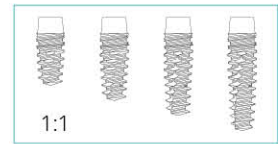
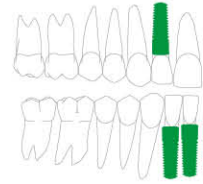

1:1

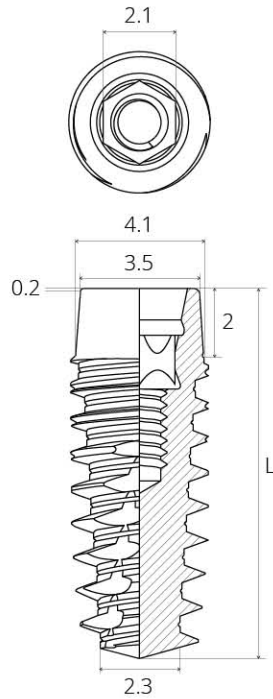

<b>∅ 3.8</b>
L
9 23164
11 23055
13 23058
15 23061



Ti

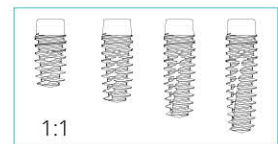
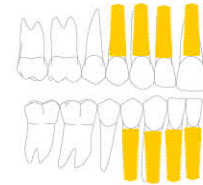

1:1

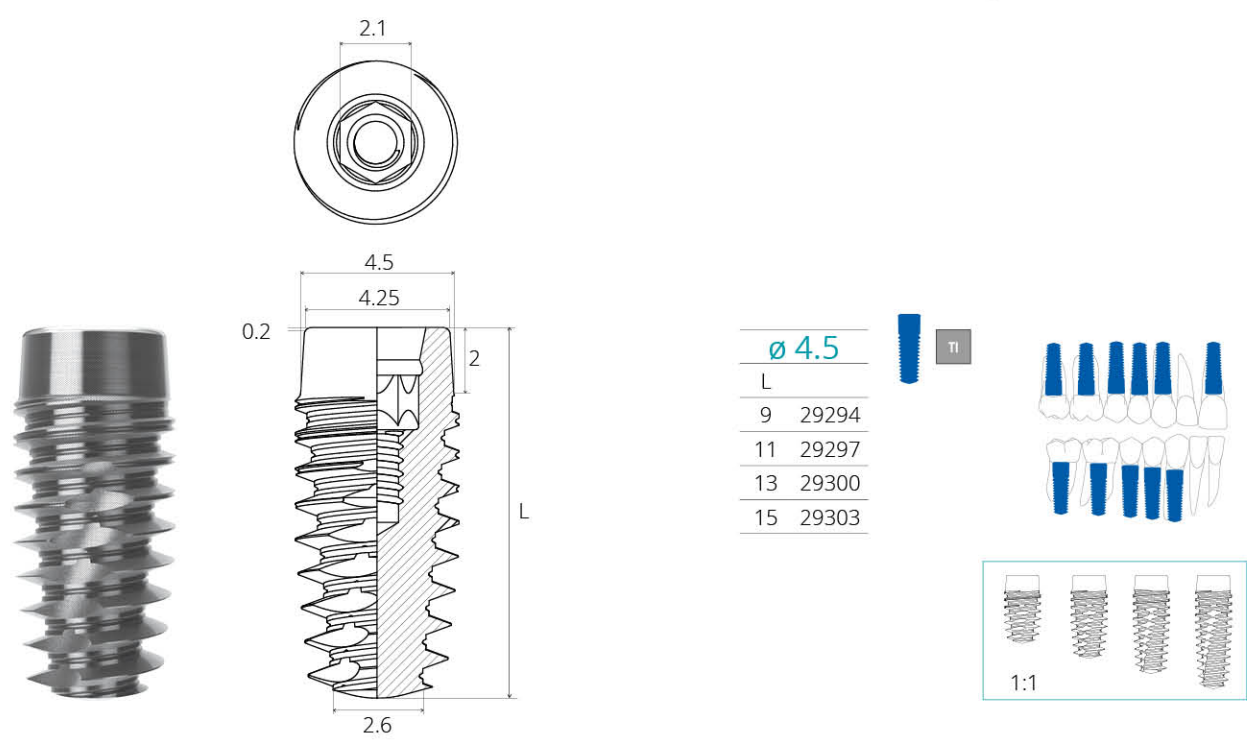







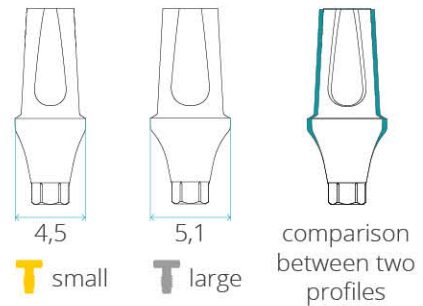



















The implants way Extra d. 4.5 prior to 2020 (code 23167 - 23064 - 23067 - 23070) presented a different connection, equal to the implants way Milano d. 4.5 and 5.5 mm.

! As the external morphology has not been modified, if both the new and previous version are present in the clinic, great attention must be paid to use the correct prosthetic components.

# Prosthetic components way Mix and way Extra



Use way Milano restorative line for way Extra implants

Healing	 Fit fixing screw		 Fixing screw h 0.6		 Healing abutment		 Wide healing abutment					
	single elements			Bridges		Structures						
Impression	 Pick-up coping		 Fine Pick-up coping		 Basic coping		 Pick-up coping		 Basic coping		 Overdenture coping	
	 Temporary abutment Single-Temp		 Temporary abutment Esthetic-Temp		 Temporary abutment Multi-Temp							
Definitive restoration	 Precision abutment		 Custom abutment		 Roller abutment		 Elpy abutment		 Moncone a finire			
	 Fusion abutment		 Fusion CoCr abutment		 Abutment for bar		 Fusion CoCr abutment		 Toronto abutment		 Abutment for bar	
				 Mua abutment		 Mua abutment		 Equator abutment				

Fixing screw is always supplied with the prosthetic components; this screw is to be used for the definitive fixing only.

## ► Management of soft tissues

### Fit screw

Supplied with the implant.  
It is ideal for cases with **thin gingival biotype**, as it closes flush with the implant seat, thus avoiding to hinder the healing of the soft tissues.

31335		
Ti		15 N·cm <i>pack 3 pcs</i>

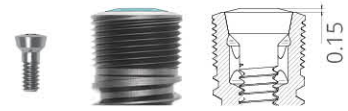

### Cover screw h 0.6

Can be bought separately.  
To be used in cases of adequate mucous thickness. The slight protrusion as compared with the implant seat prevents the growth of bone tissue over the screw itself, thus avoiding the subsequent difficulties of removal, in case the implant has been positioned below the crest.

31336		
Ti		15 N·cm <i>pack 3 pcs</i>

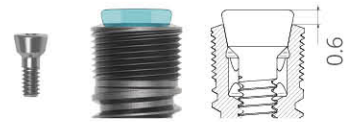

### Healing abutment

To guide the healing of periimplant soft tissues.

H	T	T
2	30191	29441
3	31342	31345
4	30193	29444
6	30195	29447
8	30197	29450

Ti  15 N·cm



### Wide healing abutment

In cases of high mucous trait.

∅	H	T	T
4,5	4	30199	
4,5	6	30201	
5,5	4	30203	
5,5	6	30205	
6,5	4	29459	
6,5	6	29462	

Ti  15 N·cm

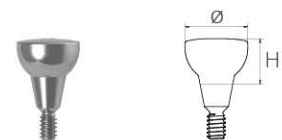

### Temporary abutment Single-Temp

For single temporary elements.

H	T	T
1	30207	29465
3	30209	29468
5	30211	29471
<i>short screw</i>		15833
<i>long screw</i>		33102

Ti   15 N·cm

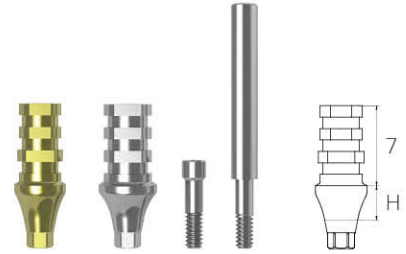

### Temporary abutment Multi-Temp

For temporary restoration on multiple elements.

H	T	T
1	30213	29474
3	30215	29477
5	30217	29480
<i>short screw</i>		15833
<i>long screw</i>		33102

Ti   15 N·cm

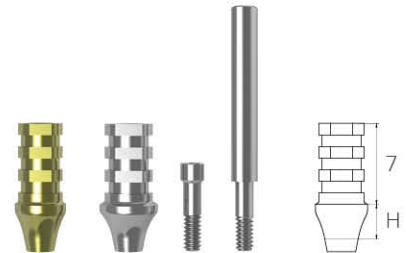

### Temporary abutment Esthetic-Temp

Ideal for esthetic areas.

H	T	T
1	31227	29483
3	31228	29486
<i>short screw</i>		15833
<i>long screw</i>		33102

PEEK  Ti  15 N·cm

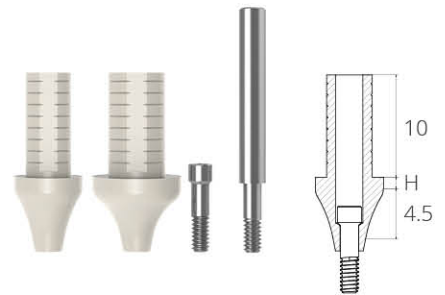

## ► Impression

### Pick-up coping

For custom impression tray.

H	T	T
3	30219	29489
<i>screw</i>		31544
7	30221	29492
<i>screw</i>		30869
<i>screw extra long</i>		29352

Ti   15 N·cm

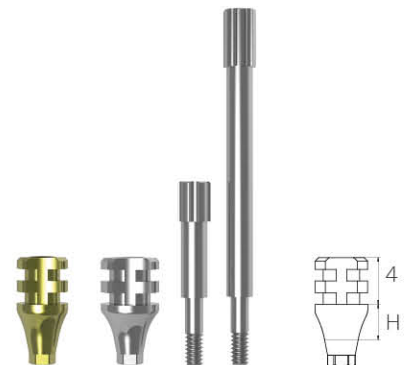

### Fine Pick-up coping

For custom impression tray, in cases of very near adjacent teeth.

	T	T
	31339	
screw	30869	
screw extra long	29352	

Ti  15 N·cm

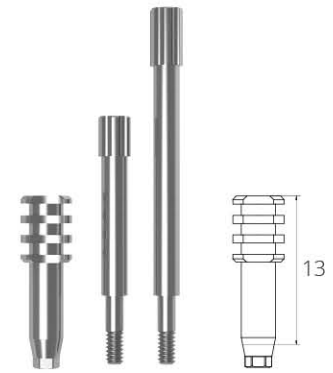

### Overdenture coping

For custom impression tray, it facilitates the impression taking in case of structures thanks to the absence of antirotational index.

	T	T
	30223	29564
screw	30869	

Ti  15 N·cm



### Basic coping

For standard impression tray.

	T	T
	31532	31535
screw	17225	

Ti  15 N·cm

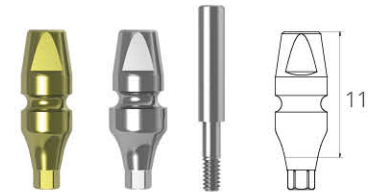

### Cap for Basic coping

To be used with Basic coping to increase the accuracy of the impression, in specific cases of disparallelism.

	16390
POM	pack 10 pcs



### Analog

It reproduces the position of the implant in the plaster model.

	T	T
	31247	

Ti 





## ► Definitive restoration

### Precision abutment

The versatile conformation makes them suitable for a wide variety of restorative solutions.

H	T	T
<b>straight</b>		
1	30225	29498
3	30227	29501
5	30229	29504
<b>angulated 15°</b>		
1	30231	29507
3	30233	29510
5	30235	29513
<b>angulated 25°</b>		
1	30237	29516
3	30239	29519
5	30241	29522
<i>screw</i>		<i>15833</i>

Ti  25 N·cm

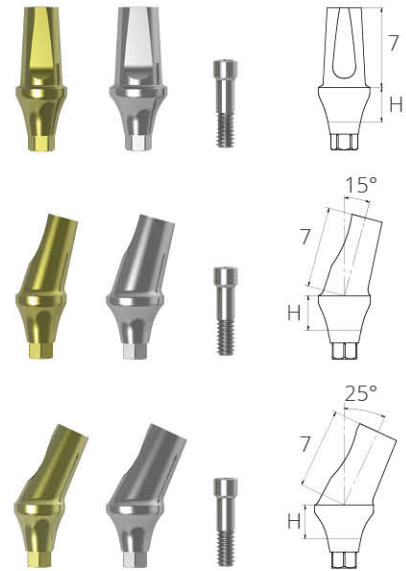

### Custom abutment

The possibility to shape a personalized abutment allows a great flexibility of use, while at the same time maintaining the precision of the industrial coupling.

	T	T
	30243	
<i>screw</i>	<i>15833</i>	

Ti  25 N·cm



### Milled Custom abutment

The specific morphology optimizes the milling operations; in some techniques, it can also be used as coping.

	T	T
	31337	
<i>screw</i>	<i>15833</i>	

Ti  25 N·cm



## Elpy abutment

It allows to start the preparation of the crown as near as possible to the implant platform.

It cannot be used with way Extra implants.

The Small version is dedicated to implants d. 3.4 and 3.8 mm.

The Large version is to be used exclusively on implants d. 4.5 mm

	T	T
straight	29568	29552
angulated 15°	29453	29555
angulated 25°	29456	29558
screw	15833	

Ti  25 N•cm

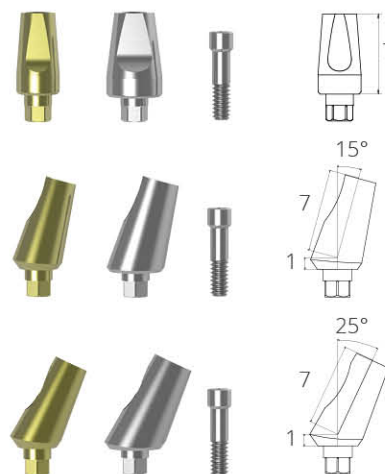

## Roller abutment

The particular design of the collar enhances and respects the anatomical profile of the soft tissues on the esthetic zones, while the pre-shaped margins facilitate laboratory works, reducing production times. The profile of the collar is oriented according to the position of the implant seat, which can be planned by using the W-fix insert.

H	T	T
	straight	
1	30245	29525
3	30247	29528
5	30249	29531
	angulated 15°	
1	30251	29534
3	30253	29537
5	30255	29540
	angulated 25°	
1	30257	29543
3	30259	29546
5	30261	29549
screw	15833	

Ti   25 N•cm

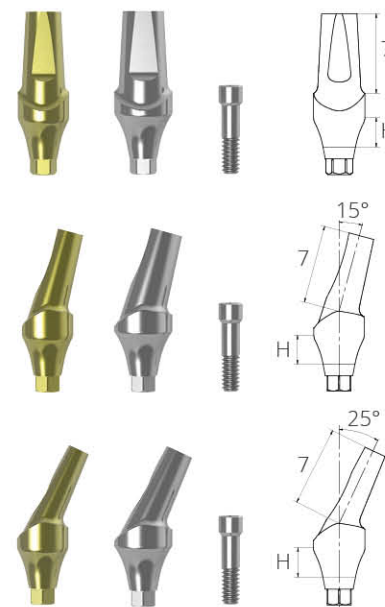

## Shoulderless abutment

Specific for the vertical preparation technique



	T	T
	30263	29561
screw	15833	





Ti   25 N•cm



### Fusion abutment CoCr

For the creation of restorations with the casting technique.

H	T	T
1	31319	non rotating 
3	31322	
		rotating 
1	31313	
3	31316	
vite	15833	

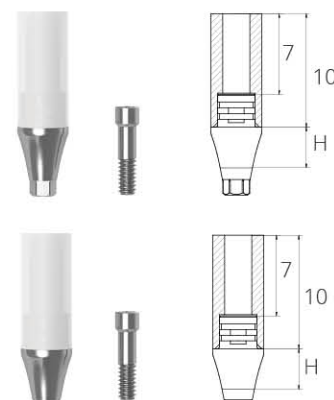

 25 N·cm



### Fusion abutment

For the creation of restorations with the casting technique.

H	T	T
1	31229	
3	31230	
screw	15833	





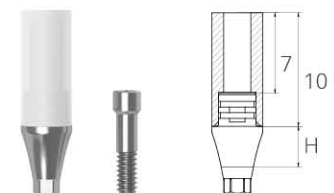

 25 N·cm





### Abutment for bar

Specific for overdenture restoration with bars.

H	T	T
1	31231	
3	31232	
screw	33101	

*castable* 

  
 4 N·cm in lab  
 25 N·cm definitive element

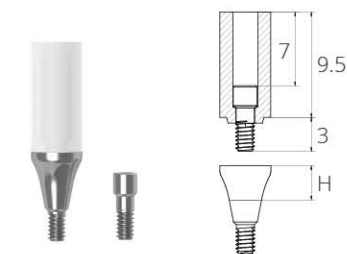



*base* 
 W-FIX 25 N·cm





### Toronto abutment

Ideal for the creation of the toronto-bridge, ensuring perfect structure fit in the oral cavity.

H	T	T
1	31233	
3	31234	
screw	33101	
<i>castable spacer</i>	33103	

*cylinder* 

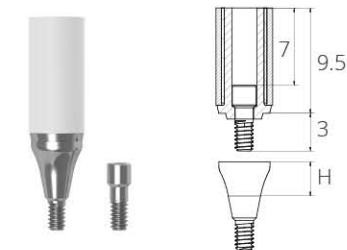

  
 4 N·cm in lab  
 25 N·cm definitive element

*base* 
 W-FIX 25 N·cm



## Equator abutment

To be used with the dedicated caps, to anchor the removable prostheses.

H	T	T
1		31235
2		31236
3		31237
4		31238
5		31239
6		31240



## Equator cap

It allows to correct disparallelism up to 25°.

Each pack contains:

- 1 container for caps in titanium
- 1 black cap for lab use
- 1 protective disk
- 4 retentive caps (1 for each retention grade)

26861
-------



## Smartbox kit

It allows to correct disparallelism up to 50°.

Each pack contains:

- 1 container with cap for lab
- 1 pink protective disk
- 4 retentive caps (1 for each retention grade)

27723
-------

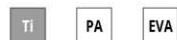

## Spare containers

Inox	Ti	Smartbox (with cap)
24088	24089	27724
pack 2 pcs		pack 1 pc

## spare caps

white/clear	yellow	pink	violet	black	black Smartbox
Standard 1800g	Extra-soft 600g	Soft 1200g	Strong 2700g	Only for lab	Only for lab
26864	26863	26865	26862	24087	27725
pack 4 pcs					

## ► Mua

Created for the **total fixed rehabilitation on distally tilted implants**, the MUA components allow the emerging parts of inclined implants in posterior sectors to be parallel, thus simplifying the prosthesis positioning, fitting and fixing. Available in the **straight** version and **angulated** at 17° and 27°, the range allows to choose between two **collar heights** (1 and 3mm).

The use of MUA abutments requires dedicated prosthetic components. In order to correctly place the MUA abutments, in many cases it is necessary to use the bone profiler to level the bone crest and create the necessary space (see page 28).



### Mua straight abutment

For easy handling, there is an accessory in peek in the pack. Once the straight abutment is positioned, simply bend and remove the accessory, pulling it out; then, fix the abutment with the Stepper insert at the indicated torque.

H	T	T
1	31241	
3	31242	

Ti PEEK 25 N·cm



### Mua angulated abutment

It includes a titanium pre-mounted accessory, which facilitates the positioning and allows to verify the direction of the prosthetic axis. Once tightened the angulated abutment with the Microesam insert at the indicated torque, remove the accessory by unscrewing it for a few rounds.

H	T	T
<b>angulated 17°</b>		
1	31243	
3	31244	
<b>angulated 27°</b>		
1	31245	
3	31246	
screw	25868	

Ti 25 N·cm

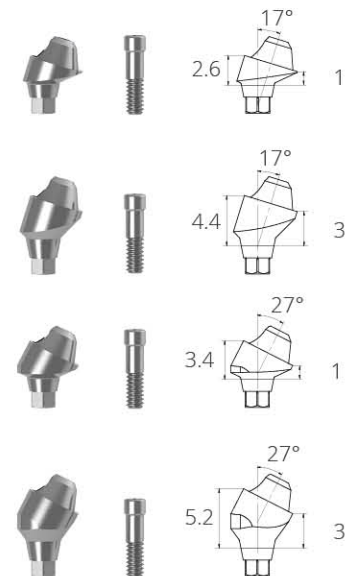

### Mua healing abutment

Used during the healing phase of soft tissues.

T	T
25848	

Ti 15 N·cm



## Mua analog

It recreates the position of the implant, on which the Mua abutment has been fixed.

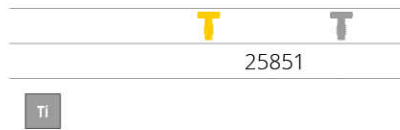

## Mua Pick-up coping

For custom impression tray.

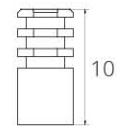
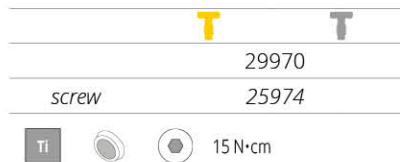

## Mua App abutment

It may act as temporary abutment, coping or as definitive solution.

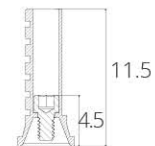
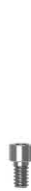
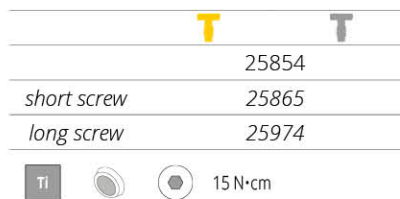

## Mua App accessories

It consists of castable part and spacer, to create a definitive restoration with the App abutment.

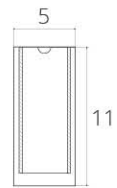
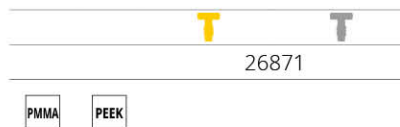

## Mua castable

To create the definitive restoration.

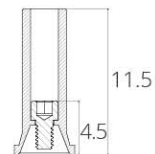
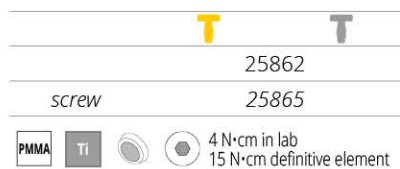





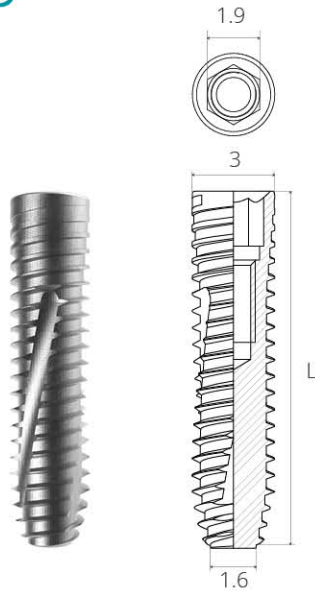

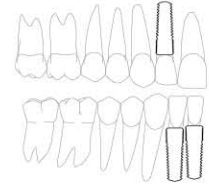

# way | slim



	<b>Ø 3</b>	<b>Ti</b>
L		
9	30479	
11	25405	
13	25406	
15	25407	



## way Slim prosthetic components

Healing	Healing abutment 		
	Single elements	Bridges	Structures
Impression	Pick-up coping 		
Temporary restoration	Temporary abutment Single-Temp 	Temporary abutment Multi-Temp 	
Definitive restoration	Precision abutment 		Equator abutment 

Fixing screw is always supplied with the prosthetic components; this screw is to be used for the definitive fixing only.

## ► Management of soft tissues

### Cover screw

Supplied with the implant.

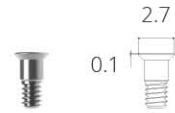

### Healing abutment

To guide the healing of periimplant soft tissues.

H	
2	23475
4	23476
6	23477

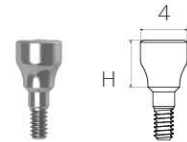

### Temporary abutment Single-Temp

For single temporary elements.

H	
1	23452
3	23455
<i>screw short</i>	15833
<i>screw long</i>	33102

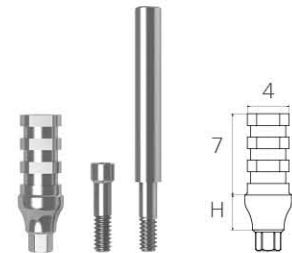

### Temporary abutment Multi-Temp

For temporary restoration on multiple elements.

H	
1	20561
3	20564
<i>screw short</i>	15833
<i>screw long</i>	33102

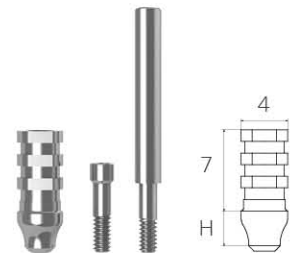

## ► Impression

### Pick-up coping

For custom impression tray.

	23478
<i>screw</i>	30869

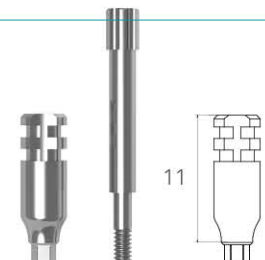

### Analog

It reproduces the position of the implant on the plaster model.

	25408
--	-------



## ► Definitive restoration

### Precision abutment

Suitable for a wide variety of restorative solutions.

H	
<b>dritto</b>	
1	23458
2	23461
4	23464
<b>angolato 15°</b>	
1	23467
2	23470
4	23473
<i>vite</i>	15833

Ti  25 N·cm

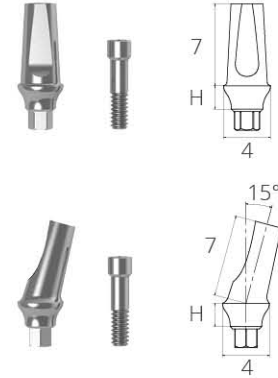

### Equator abutment

To be used for rehabilitation with removable prostheses, together with the caps and the dedicated accessories (see page 53).

H	
1	26472
2	26475
3	26478
5	26481

Ti  25 N·cm

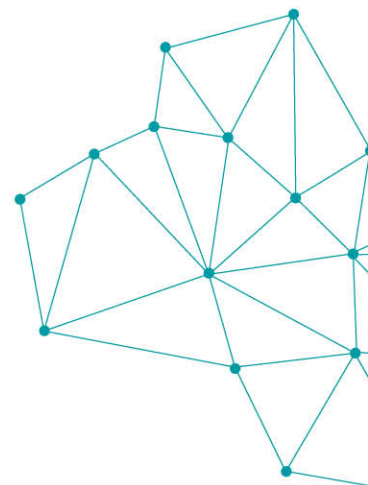

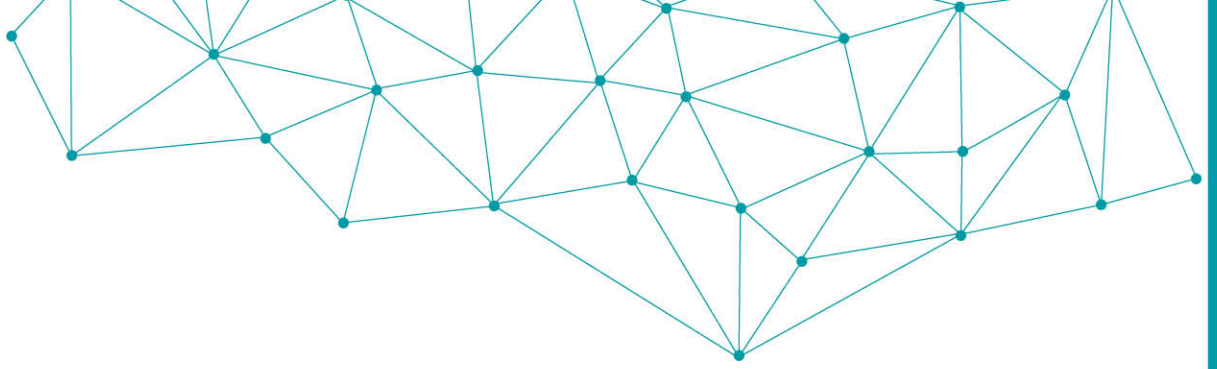

way|rock



way|short



# way | rock

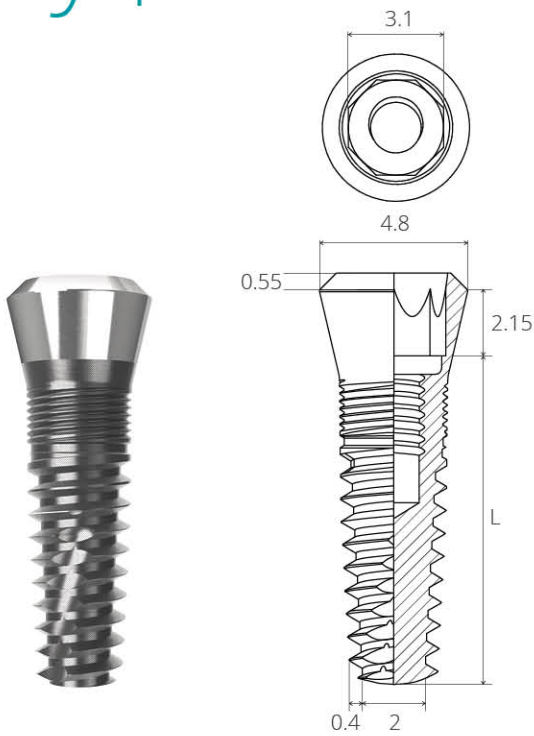

**ø 3.4**  
platform 4.8

L	
11	30585
12	30588
13	30591
15	30594



Ti

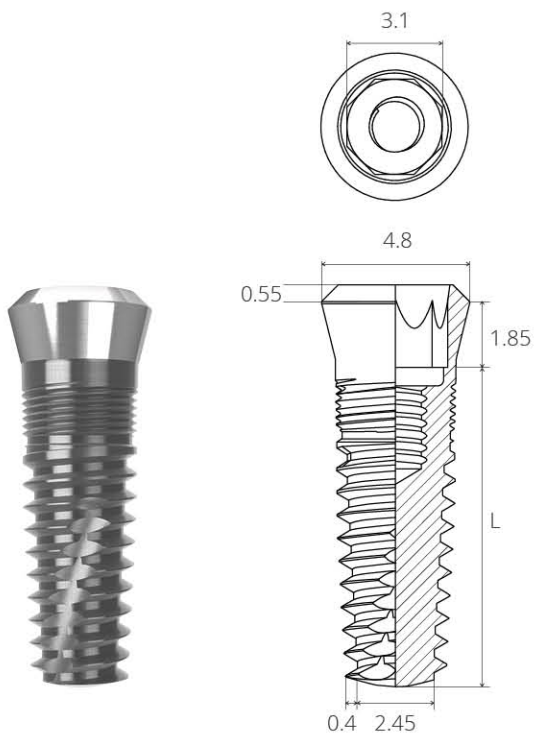
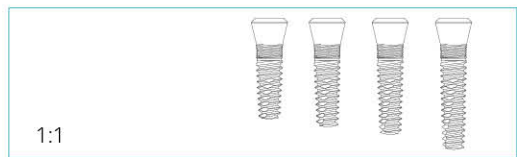
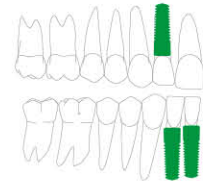

**ø 3.8**  
platform 4.8

L	
8	30597
9	30600
10	30603
11	30606
12	30609
13	30612
15	30615



Ti

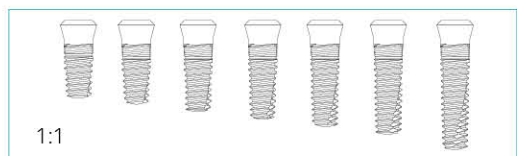

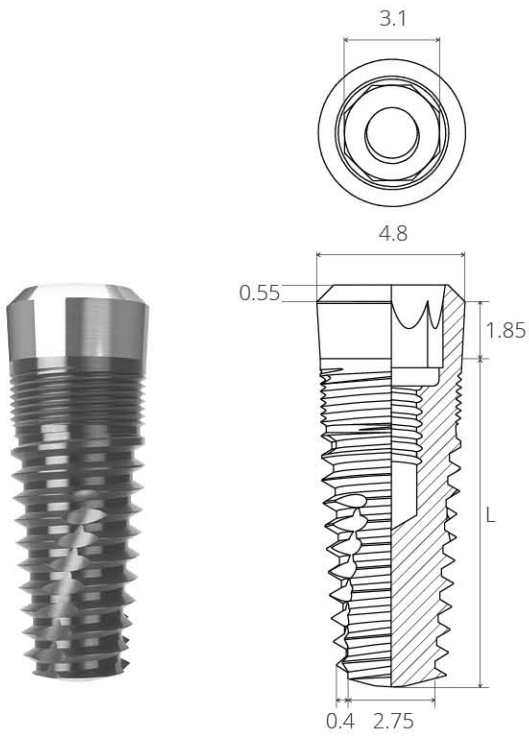

**ø 4.5**  
platform 4.8

L	
8	30618
9	30621
10	30624
11	30627
12	30630
13	30633
15	30636

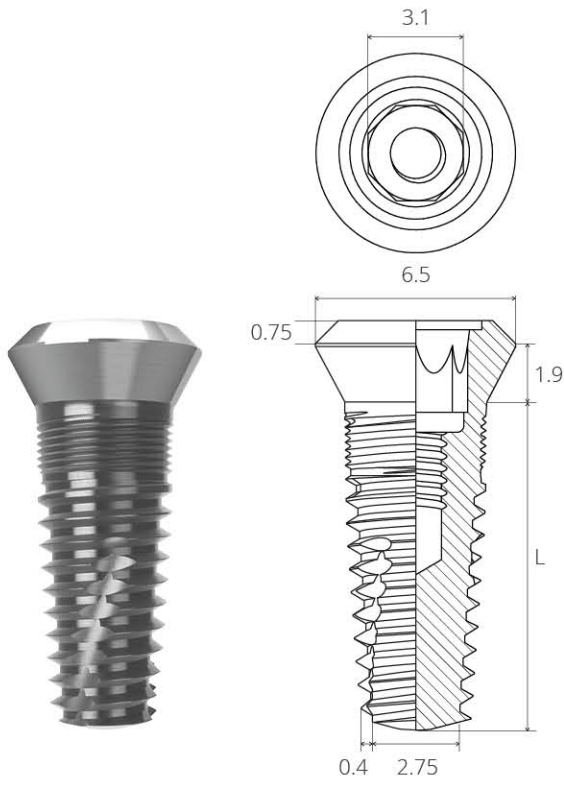
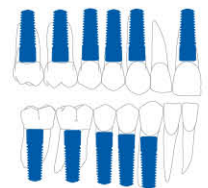

**ø 4.5**  
platform 6.5

L	
8	30639
9	30642
10	30645
11	30648
12	30651
13	30654
15	30657

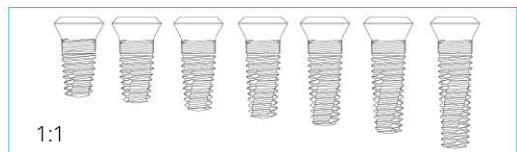
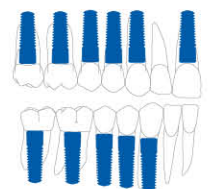



# way | short

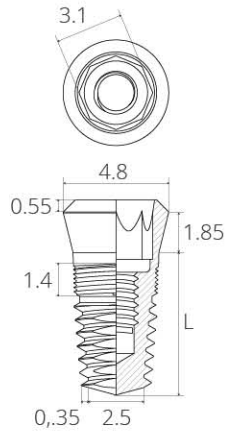

<b>ø 3.8</b>
platform 4.8
L
5 27274
6.5 27277



Ti

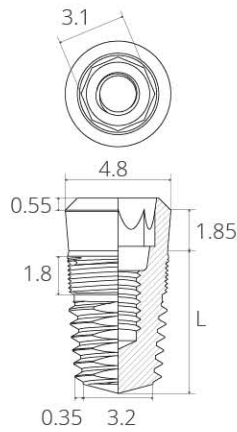
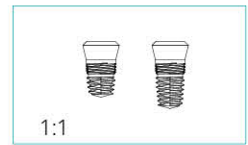

<b>ø 4.5</b>
platform 4.8
L
5 19788
6.5 19782



Ti

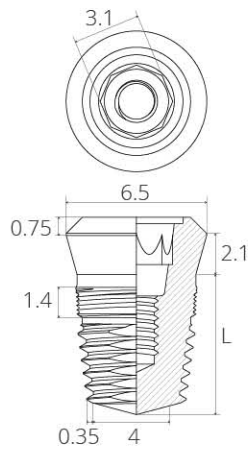
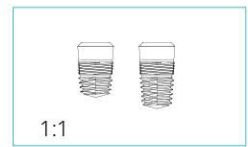
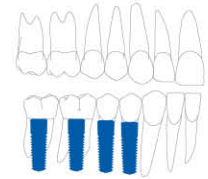

<b>ø 5.5</b>
platform 6.5
L
5 19785
6.5 19779





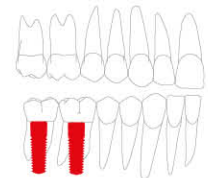













Ti



# way Rock and way Short prosthetic components

Use way Rock restorative line for way Short implants

Healing	 Healing abutment		
	Single elements	Bridges	Structures
Impression	 Pick-up coping		 Basic coping
	 Temporary abutment Single-Temp		 Temporary abutment Multi-Temp
Definitive restoration	<b>Cemented</b>  Precision abutment		 Rotative abutment
	 Custom abutment		 Slender abutment
<b>Screwed</b>  Fusion abutment		 Fusion CoCr abutment	 Abutment for bar
 Fusion CoCr abutment		 Toronto abutment	 Abutment for bar
 Reflect abutment		 Equator abutment	

Fixing screw is always supplied with the prosthetic components; this screw is to be used for the definitive fixing only.

## ► Management of soft tissues

### Cover screw

Supplied with the implant.

	T	T
	33116	33117

Ti  15 N·cm



### Healing abutment

To guide the healing of periimplant soft tissues.

H	T	T
2	31358	31361
3	31359	31362
5	31360	31363

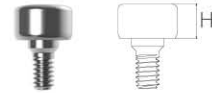

Ti  15 N·cm



### Single-Temp abutment

For single temporary elements.

H	T	T
in PEEK		
	31364	31365
short screw	33107	
long screw	33108	

PEEK  Ti   15 N·cm

H	T	T
in TITANIUM		
	31366	31367
short screw	33107	
long screw	33108	

Ti   15 N·cm

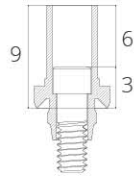

### Multi-Temp abutment

For temporary restoration on multiple elements.

H	T	T
in PEEK		
	31368	31369
short screw	33107	
long screw	33108	

PEEK  Ti   15 N·cm

H	T	T
in TITANIO		
	31370	31371
short screw	33107	
long screw	33108	

Ti   15 N·cm

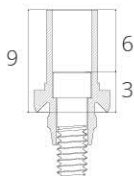

## ► Impression taking

### Pick-up coping

For custom impression tray.

H	T	T
3	31372	31374
<i>screw</i>	33114	
6	31373	31375
<i>screw</i>	33108	

Ti   15 N·cm

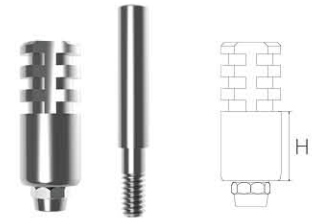

### Basic coping

For standard impression tray.

H	T	T
	31376	31377
<i>screw</i>	33114	

Ti   15 N·cm

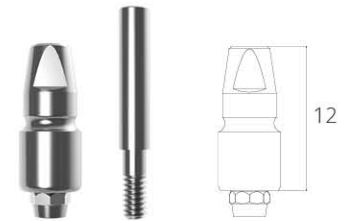

### Cap for Basic coping

To be used with Basic coping to increase the accuracy of the impression, in specific cases of disparallelism.

	16390
<b>POM</b>	<i>pack 10 pz.</i>



### Analog

It reproduces the position of the implant in the plaster model.

H	T	T
	31378	31379

Ti 



## ► Definitive restoration

### Precision straight abutment

Versatile conformation; suitable for a wide variety of restorative solutions.

H	T	
1	31380	
2	31381	
3	31382	
<i>screw</i>	33107	

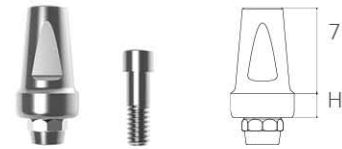

### Rotative abutment

Made from two distinct components, they allow for a rotation of 360° of the coronal part of the abutment. Once the best position has been selected, the two components are fixed with the passing screw.

H	T		T
	angulated 15°		
1	31383	31387	
3	31384	31388	
	angulated 25°		
1	31385		
3	31386		
<i>screw</i>	33109		



### Custom abutment

It allows for maximum personalization, while at the same time maintaining the precision of the industrial coupling.

	T	T
	31389	31390
<i>screw</i>	33107	



### Slender abutment





It allows you to manage cases where the gingival tissue tends to have a very thin thickness.

H	T		T
	straight		
	31391	31394	
<i>screw</i>	33107		
	angulated 15°		
	31392	31395	
	angulated 25°		
	31393	31396	
<i>screw</i>	33113		



## Fusion abutment Co Cr

For the creation of restorations with the casting technique.

	T	T
	31328	31334
	non rotating 	
	31325	31331
	rotating 	
<i>screw</i>	33107	
<b>PMMA</b>	<b>TI</b>	<b>CoCr</b>
		
	35 N·cm	

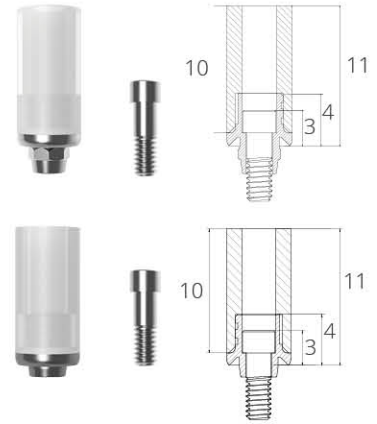

## Fusion abutment

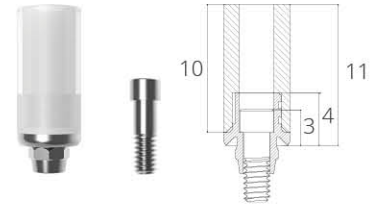

For the creation of restorations with the casting technique.

H	T	
1	31397	
<i>screw</i>	33107	
<b>PMMA</b>	<b>TI</b>	
	<b>Au lega</b>	
		
		
	35 N·cm	



## Abutment for bar

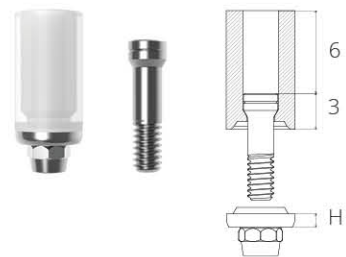

Specific for overdenture restoration with bars.

H	T	T
1	31398	31400
<i>screw</i>	33111	
3	31399	31401
<i>screw</i>	33112	
<i>castable</i>	<b>PMMA</b>	
	4 N·cm in lab 35 N·cm prosthetic artifact	
<i>base</i>	<b>TI</b>	



## Toronto abutment

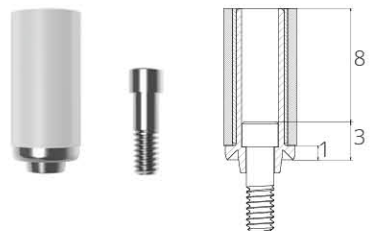

Ideal for the creation of the toronto-bridge, ensuring perfect structure fit in the oral cavity.

	T	
	31402	
<i>screw</i>	33107	
<i>castable spacer</i>	33119	
<b>TI</b>	<b>PMMA</b>	
	<b>PEEK</b>	
		
		
	35 N·cm	



## Compact abutment

Characterized by its mechanical solidity which comes from its full structure and the conical coupling

	T	T
4	31403	31406
5,5	31404	31407
7	31405	
<b>TI</b>		
	35 N·cm	

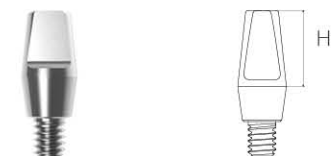



## Equator abutment

To be used for rehabilitation with removable prostheses, together with the caps and the dedicated accessories (see page 53)

	T
1	31408
2	31409
3	31410
4	31411
5	31412
6	31413

Ti  35 N·cm



## ▶ Reflect

### Reflect abutment

Designed for the creation of screw-retained restorations. Once tightened on the implant, it must not be removed; it requires dedicated components.

	T	T
	31414	31415

Ti  35 N·cm



### Reflect Pick-up coping

For custom impression tray.

	T	T
	31416	31417
<i>screw</i>		33115

Ti  15 N·cm

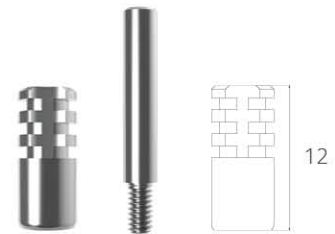

### Reflect analog

It reproduces the position of the implant with the Reflect abutment on the plaster.

	T	T
	31418	31419

Ti



### Reflect Melty abutment

To create a definitive restoration on the Reflect abutment.

	T	T
	31420	31421
<i>screw</i>		33110

Ti  PMMA 4 N·cm in lab  
35 N·cm prosthetic artifact

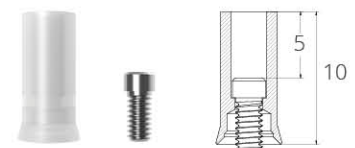

# digitals

## Digital evolution

The digital solutions proposed by Geass constitute an **open, flexible and economical system** that allows you to:

- acquire a complete digital flow;
- utilise **innovative technologies** that are **adaptable** to any IT system;
- implement your own digital structure with **versatile equipment and instruments**;
- define an **effective surgery-laboratory work flow**.

Geass is able to offer **complete, professional service** for your informed investment in the digital world, with **specific consultancy, operational support** in your surgery and in the lab, **events and training courses** and **after-sales assistance** on-site and remotely.

### Digital impression taking

#### Intraoral scanner

**Ease of use, fluid process of image acquisition, precision results:** all this for an excellent workflow, accurate and fast.



### Computer assisted surgery

#### Gedrive, Geass 3D and Digital Pack

Gedrive is the **computer assisted surgery** which allows you to carry out accurate and complete **diagnoses**, plan the optimal position of the implant and design the prosthetic rehabilitation while operating in total **safety**.

Also in the Digital Pack version to exploit the potentiality of the guided surgery on a single case



### cad-cam personalized prosthesis

#### Performa

To overcome the limits of the current CAD-CAM productions on implants, Geass uses an **innovative technology** which **integrates** the **advantages** of **milling** with those of machine turning.

Various solutions in several types of Zirconia, PMMA and laser melting complete the Performa offer.



# Gedrive

## Gedrive way organizer

*instruments not included* 28475

PPSU SI

Gedrive Bluebox is an organizer designed to contain in a rational and functional manner:

- the **Gedrive Start** drills, to carry out guided surgery in the initial phases;
- the drills, wrenches and inserts of the **Final Gedrive**, to be assisted right up to implant placement.



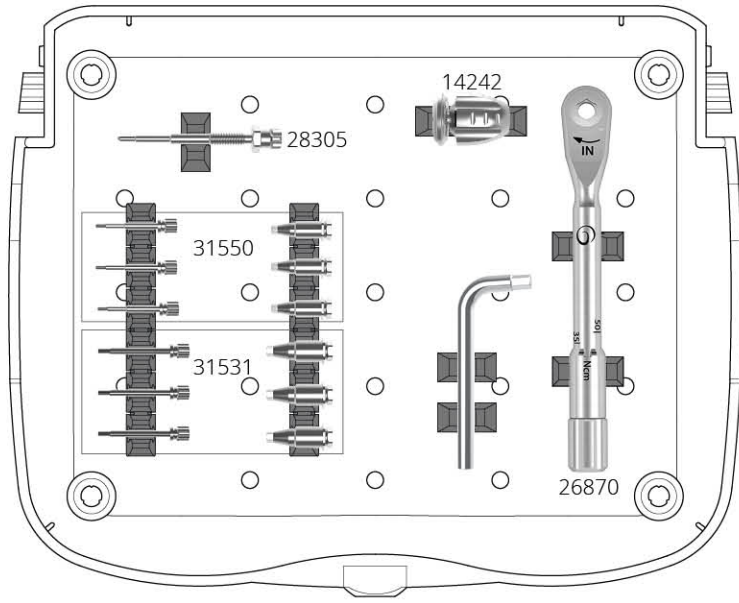
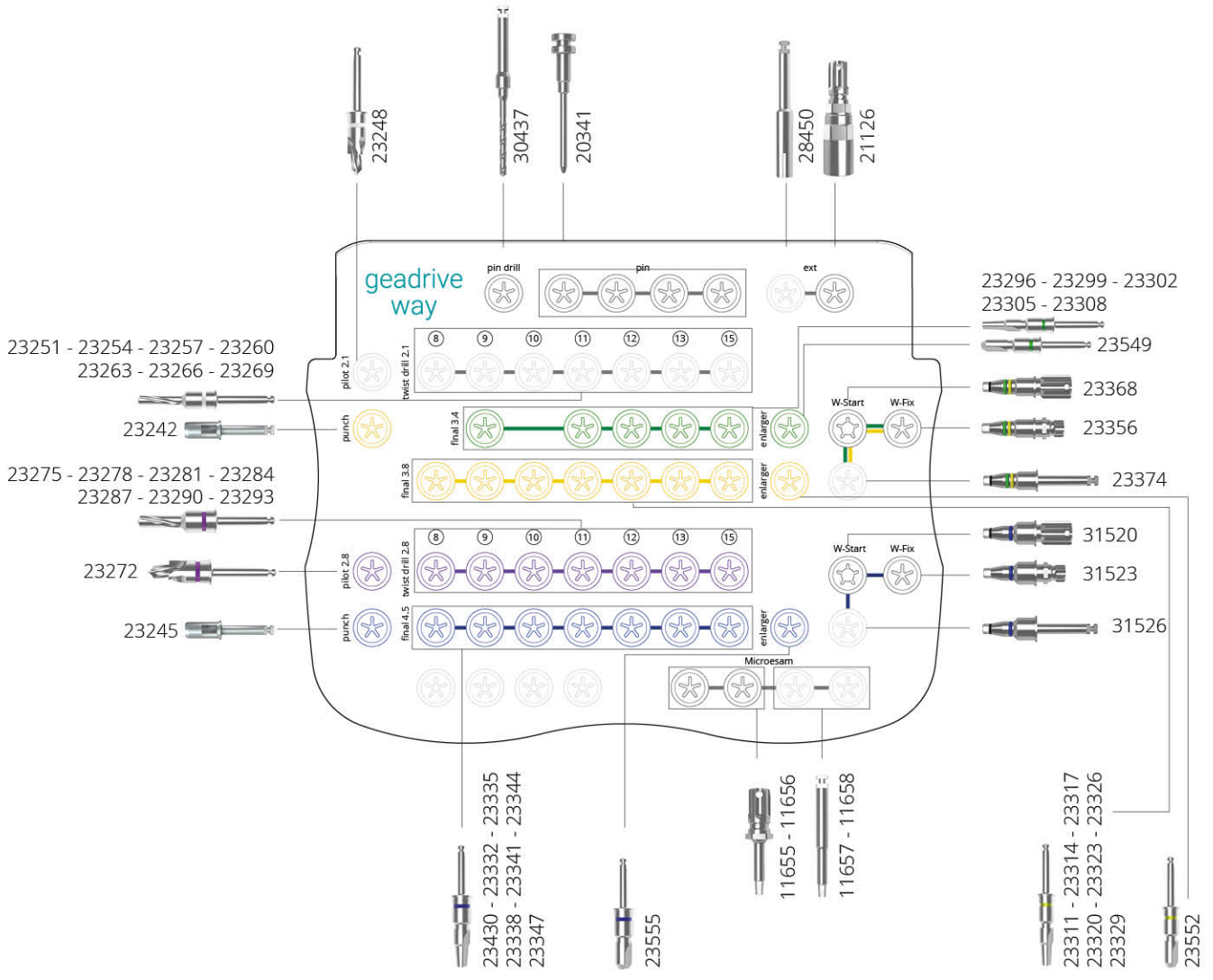

## Drill for pin

	30437
--	-------

Inox

Allows you to create a seat for the fixing pins.; maximum speed: 500 rpm



## Fixing pin

	20341
--	-------

Ti

Allows you to fix the surgical guide.



## Mucotome

ø 3.8	23242
ø 4.5	23245

Inox

To incise and remove the soft tissues; maximum speed: 40 rpm.



## Centering drill

ø 2.1	□	23248
ø 2.8	■	23272

Inox

It creates the first osteotomy to facilitate the precise centering and positioning for the subsequent drills, thus levelling the bone crest at the same time, if necessary. Maximum speed: 400 rpm.



## Twist drill

		8	9	10	11	12	13	15
ø 2.1	□	23251	23254	23257	23260	23263	23266	23269
ø 2.8	■	23275	23278	23281	23284	23287	23290	23293

Inox

For the initial preparation of implant site; the integrated stop guarantees more safety. Maximum speed: 400 rpm.





## Final drill



	8	9	10	11	12	13	15
		23296		23299	23302	23305	23308
	23311	23314	23317	23320	23323	23326	23329
	23430	23332	23335	23338	23341	23344	23347

 Inox

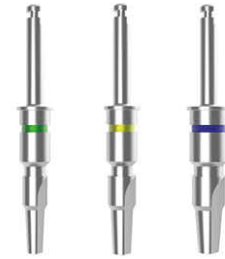
The final drill allows you to complete the implant site with widening adequate to the dimensions of the implant; maximum speed: 300 rpm.



## Enlarger drill



	23549
	23552
	23555

 Inox

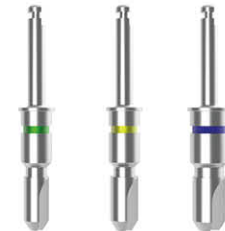
To be used in cases of D1 bone; maximum speed: 300 rpm.



## W-Start screwdriver



		
	23368	31520
<i>o-ring. (3 pcs)</i>	15928	15928

 Ti  SI  PU

To remove the implant from touch&go holder and insert it for some threads into the implant site. It differs from the W-Fix insert for the presence of the o-ring and for the fact that it cannot be used with the Newton screwdriver.



## W-Start driver

		
	23374	31526
<i>o-ring. (3 pcs)</i>	15928	15929

 Inox  SI  PU

To remove the implant from touch&go holder and insert it for some threads into the implant site. It differs from the W-Fix insert for the presence of the o-ring.



## W-Fix insert

		
	23356	31523

 Inox  PU

To be used with the screwdriver and the Newton torque wrench to complete the implant insertion into the implant site.



The other instruments hosted in the Geadrive organizer are in common with the traditional surgery (pages 24 to 39).



## Contra angle adapter



	29358
<i>o-ring. (3 pcs)</i>	21144



To handle the mounters with the micromotor.



## Mounter

		
31550	31531	



It allows to remove the implant from the touch&go holder and to place it into the implant site; it can be used with the screwdriver and the Newton screwdriver.

**Do not exceed the torque of 50 Ncm.** Left into the implant site, it helps to maintain the surgical guide in the correct position until the end of the intervention.



## Mounter extractor

	28305
--	-------



Screwed into the mouter instead of the screw, it allows to remove it, in case it remains blocked in the implant seat.



## Sleeve for guide

∅ 4.2	26511
∅ 5.2	26514



Fixed on the surgical guide, it allows to guide the drills so that the osteotomy corresponds to the virtual planning of the treatment. The sleeve d. 4.2 is to be used with the implants d. 3.4 and 3.8 mm; the sleeve d. 5.2 is to be used with the implants d. 4.5 mm.



## Sleeve for pin

	28047
--	-------



Fixed on the surgical guide, it allows to guide the drill for pin.



# Performa

## Scanbody

To transfer the position of the implant from reality to the CAD software in three dimensions. **They always have to be matched up with Geass library; the use of the matting spray is not required during scanning;**

To tighten with Performa Torque at 4 N•cm.

As it is **sterilizable**, it can also be used for **intraoral scanning**; in this case use the Performa insert for fixing.

way Mix - way Extra	way Slim	way Rock - way Short		Mua
		T b.4.8	T b.6.5	
short 31153	short 25331	31435	31436	26551
long 31154	long 27251			
Ti PEEK	Ti PEEK	Ti PEEK	Ti PEEK	PEEK



## Linker

Bases in titanium, on which it is possible to create CAD-CAM ceramic elements, especially suitable for cases of high **aesthetic value**. Characterised by knurling which facilitates retention of the cement. Colouring is yellow to reduce the metal reflection in transparency and to therefore improve the aesthetic outcome.

The **height** of the Linker is easily adaptable to the clinical situation, thanks to the **pre-cut groove** which, finding correspondence in the **libraries**, also facilitates the technician in the design of the prosthesis.

	way Mix - way Extra	way Slim	way Rock - way Short		Mua
			T b.4.8	T b.6.5	
	H0 31156	29375	31441	31442	
	H3 31157				
	H0 31158	29378	31443	31444	H0 29088
	H3 31159				H1.5 29089
N•cm	25	25	35	35	25

Ti

Linkers are available in two versions::

- V3: for way Mix, way Extra; they have total height 10 mm and three pre-cutting grooves.
- V2: for way Slim and Mua; they have total height 6 mm and a pre-cutting groove at 4 mm.

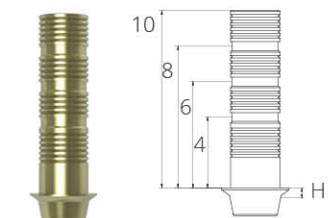
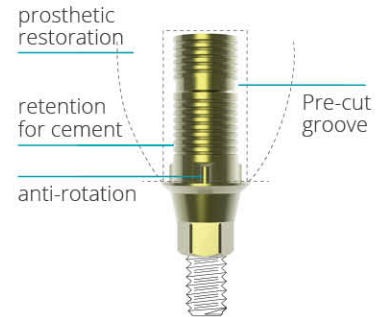

Linker V3

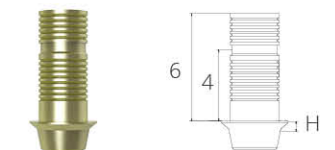

Linker V2

**! Always verify the correct matching between the Linker to be used and the respective library**

## Base for wax-up

To be used in the laboratory to model the wax-up, then to be sent subsequently to Geass for digitalization.

way Mix - way Extra	way Slim	way Rock - way Short		Mua
		T p.4.8	T p.6.5	
31160	25421	31439	31440	27308

PMMA

pack 10 pcs



## Ti-Base Sirona

	way Mix - way Extra	way Slim	way Rock - way Short	
			T p.4.8	T p.6.5
	31430	25632	31445	31446
N·cm	25	25	35	35

Ti



## Digital analog

Specific for processing that derive from **taking digital impressions**, it ensures correct repositioning on the 3D printed model thanks to the presence of hexagonal sides, which also facilitate insertion.

The screw, included in the pack, ensures analog stability in the model and in many cases avoids the use of adhesive substances. The screw must be tightened with the Performa Torque tool.

Geass digital analogs are complete with the implant libraries necessary for virtual modelling through the main CAD softwares and for the creation of models using 3D printing.

way Mix - way Extra	way Slim	way Rock - way Short		Mua
		T b.4.8	T b.6.5	
31155	28249	31437	31438	28261

Ti



### Performa screwdriver

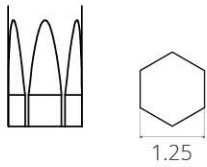

23918

Inox

To be used in the oral cavity to handle the scanbody on the implants.

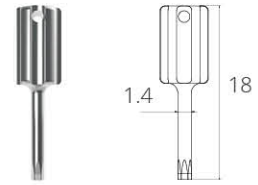

### Performa driver

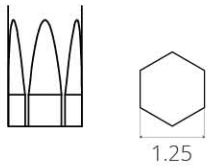

28472

Inox

To be used in the oral cavity to handle Geass scanbody on the implants with micromotor.

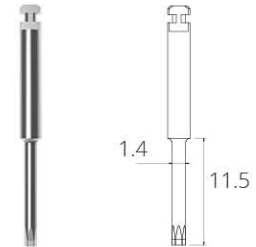

### Inclined hole insert



short	25449
long	25112

Inox

For tightening screws on tilted holes, used in CAD-CAM prosthesis. The definitive tightening of the screws on tilted holes is foreseen at 25 Ncm, except the screws on Mua which are to be tightened at 15 Ncm.

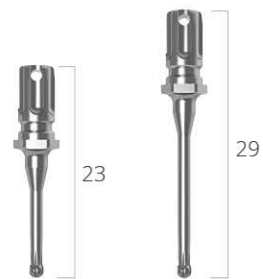

### Inclined hole driver

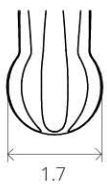

short	25455
long	25452

Inox

For tightening screws on tilted holes, used in CAD-CAM prosthesis, with micromotor. The definitive tightening of the screws on tilted holes is foreseen at 25 Ncm, except the screws on Mua which are to be tightened at 15 Ncm.



### Performa Torque

23788

Inox

POM

To be used exclusively in the lab to tighten the scanbody and the PMMA castables on the analogs, at a pre-defined torque of 4 Ncm.



# advanced

## Regenerative solutions

### Easy Bone Management

#### EBM organizer

*instruments not included* 30377



For storing and organizing EBM drills.



#### Spherical EBM drill ø 5

29317



For sinus elevation with EBM technique, in compact bone.



#### Spherical EBM drill ø 7

29320



For sinus elevation with EBM technique, in soft bone.

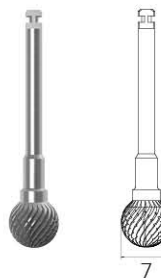

#### Oval EBM drill ø 6

29323



To model the crestal portion of maxillary bones.

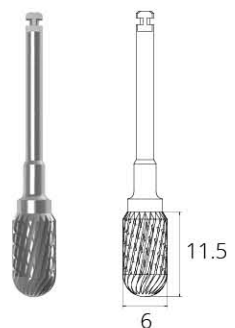

# Sinus lift

## Osteotome organizer

*instruments not included* 16499

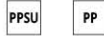

To store and organise the osteotomes simply.



## Osteotome insert

L			
9	11460	11466	11472
10	11461	11467	11473
11	11462	11468	11474
12	11463	11469	11475
13	11464	11470	11476
15	11465	11471	11477



Specific for the minor sinus lift technique with way implants, it allows you to fracture the sinus cortical bone, raising it along with the membrane.



## Osteotome handle

11459



The insert suitable to the type of selected implant is to be inserted onto the hand piece.



## Angled adapter for osteotome

16496



Inserted onto the hand piece, it allows to reach the less easy areas.



## Surgical mallet

2995.Y0.05



It allows you to calibrate the force and concentrare it in a short instant, thus obtaining a precise fracture.



## Endosteal elevator

*n.1* 11479

*n.2* 11480

*n.3* 11481



Ideal to easily access the antral window, allowing you to carry out elevation of the sinus endosteum.





## Split crest

### Chisel double edge

		width
		3
		6
		9

Inox

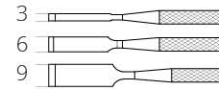
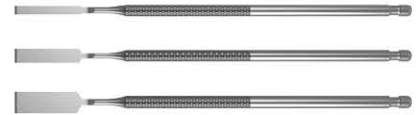

Used to increase the transverse volume in greenstick osteotomy interventions.

### Widener organizer

*instruments not included* 30545

PPSU

SI

Tray to effectively store the wideners and the handling instruments. The serigraphy allows to immediately identify the widener and the instruments to be used.



### Widener

No.	ø pilot hole	ø apical	ø	ø	ø	ø	ø	ø
			L. 8	L. 9	L. 10	L. 11	L. 12	L. 13-15
1	15702	2.0	2.20	2.25	2.30	2.35	2.45	2.50
2	15703	2.5	2.60	2.65	2.70	2.75	2.85	2.90
3	15704	2.8	2.95	3.00	3.10	3.15	3.25	3.30
4	15705	3.0	3.15	3.20	3.30	3.35	3.45	3.50
5	15706	3.5	3.60	3.70	3.75	3.85	3.90	4.00
6	15707	4.0	4.15	4.20	4.30	4.35	4.45	4.50

Ti

They allow you to gradually enlarge the crest, expanding the available bone and reducing surgical trauma. They increase the transverse volume in presence of thin edentulous ridges with suitable height.

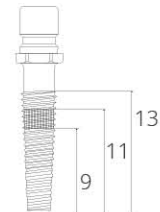

### Insert extension

		21126
<i>o-ring</i>	<i>pack 3pcs</i>	21144

Inox

SI

It allows you to use the wideners in less accessible areas or between two dental elements.



# Bone regeneration

## Tack holder

tacks not included	11342
--------------------	-------



To conserve and organise the tacks tidily.



## Tack inserter

	11392
--	-------



For the removal of the tack from the support and for positioning it *in situ* in conjunction with the mallet.



## Tack

	L	
	3	11369
	5	11370



pack 3pcs

Used for fixing membranes.

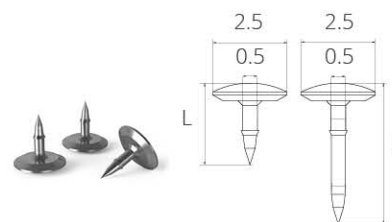

## SQ12 SQ17 organizer

instruments not included	11341
--------------------------	-------



It contains instruments and microscrews for fixing grafts, meshes and plates.



## Drill SQ12 ø 1.0

short	11355
long	11356



For creating an entrance on the cortical for the microscrews SQ12.



## Drill SQ17 ø 1.3

short	11357
long	11358



For creating an entrance on the cortical for the microscrews SQ17.



## Manual spanner

SQ12	11344
SQ17	11345

Inox



It provides excellent sensitivity when inserting the microscrew while applying adequate torque to it.

## Contra-angle

SQ12	11346
SQ17	11347

Inox



Extremely useful in areas which are difficult to reach thanks to the fitting on the hand piece.

## Screwdriver

SQ12	11348
SQ17	11349

Inox



To handle microscrews in the frontal region, allowing excellent directional control and of the torque applied.

## Microscrew SQ12 $\varnothing$ 1.2

L	
3	11371
4	11372
5	11373
6	11374
7	11375
8	11376
11	11377

Ti

pack 3pcs

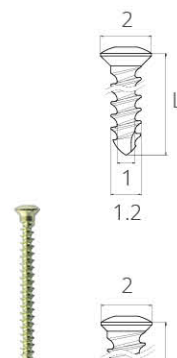

## Emergency microscrew SQ12 $\varnothing$ 1.5

L	
4	11378
6	11379
8	11380

Ti

pack 3pcs

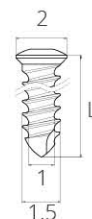

Ideal for the fixing of meshes and plates.

## Microscrew SQ17 ø 1.7

	L	
	9	11385
	11	11386
	13	11387

Ti *pack 3pcs*

## Emergency microscrew SQ17 ø 2.0

	L	
	11	11390
	13	11391

Ti *pack 3pcs*

Ideal for the fixing of bone grafts.

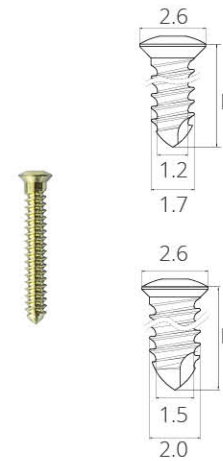

## Biomaterials of synthetic origin

### Granuli Adbone BCP



dimension	g	
	0.5	BCP010505G
Fine 0.1-0.5 mm	0.5-5pz	BCP010505P
	1	BCP010510G
	1-5pz	BCP010510P
Medium 0.5-1 mm	0.5	BCP050105G
	0.5-5pz	BCP050105P
	1	BCP050110G
	1-5pz	BCP050110P
Course 1-2 mm	1	BCP010210G
	1-5pz	BCP010210P



Adbone BCP is a **porous synthetic biomaterial in granules**, made up of 25 % of Tricalcium phosphate (TCP) and 75% of Hydroxyapatite (Hap). The **biphasic composition** makes it possible to achieve **optimal reabsorption in two stages**, compatible with the rapid formation of the bone and the maintenance of the architecture of soft tissues.

### Membrane Tisseos

dimension	
15x20	TO1520
15x25	TO1525
20x30	TO2030
30x40	TO3040

Tisseos is a double layer **synthetic membrane**, **biocompatible** and **totally reabsorbable**, ideal for guided regeneration of the bone and soft tissues.



## Biomaterials of heterologous origin

### Osteoxenon

Complete line of collagenated bone substitutes of equine origin: granules in vial, granules in syringe, blocks, flexible sheets and membranes.

The enzymatic deantigenation allows to preserve the collagen of bone, guaranteeing a total remodelling in physiological terms.



### Activabone bone pastes

Equine bone substitutes, associated to an innovative polymer carrier with modulated viscosity, to adapt perfectly to bone defects of any dimension or shape.



### Membrane Heart

Equine origin pericardium membrane, characterized by a particularly long protection time (3-4 months), high adhesiveness to tissues and excellent tensile strength.



### Xenomatrix

Tridimensional collagen matrix for the regeneration of soft tissues.



## Ozosan gel

Patented gel, containing stabilised ozone. It acts against bacteria, virus, fungi and it has anti-inflammatory, haemostatic and biostimulating effects.



## Surgical sutures



A wide range of high quality sutures for the most demanding surgeons. In various types, absorbable and non absorbable.

absorbable



non absorbable







# 100% producers of smile

Geass is the Italian company which has achieved quality and **innovation** over the last thirty years, offering implant-restorative solutions in order to obtain excellent results.

An internal production line, rigid quality control and next generation technology are all guarantees for reliability of the product, safety and innovation.

## www.geass.it

Keep updated with all the latest news on Geass website.



## shop.geass.it

A modern tool for your purchases and lots of new promotions.



## Social media

News and updates on Geass products and events.



## Communication to patient

Materials to help clinicians explain implant treatments and the digital technologies used in clinic.



## Smile club

Smile club is a loyalty program that offers access to exclusive benefits, giving even more value to clinicians and their activity.





## ► Warnings and sales conditions

### Warnings

#### 1. Manufacturer responsibility (according to the 93/42 EEC Directive and subsequent amendments)

The Way implant-restoration system is made up of a number of medical devices for Dentistry according to the Directive, aimed at dental restoration of the oral cavity of human beings. The instruments and components dedicated for this purpose make up an integral and indispensable part of the system and must therefore always be used for the application of Way dental implants, scrupulously following the instructions and recommendations supplied by the manufacturer (according to the Directive). Every use of the Way system which is different from the one stated or the use of instruments or components in a manner different to the one foreseen or the use of instruments or components which do not belong to the system, produced by third parties, compromises the functionality of the Way system and is considered as 'improper use', exonerating the manufacturer from any obligation or responsibility. Information concerning the use of Geass products is supplied to the user in written form in paper documentation, like the instructions for use, surgical and restorative protocols, in electronic form (audiovisual and IT instruments) or potentially through practical demonstrations (training courses). These correspond to the current state of art recognized on commercialization of the product and only constitute a supplement to a professional education and experience, as they are not sufficient for an immediate use of the Geass implant systems.

#### 2. User responsibility

Choice and application of the product are acts carried out by the Clinician in total autonomy of judgement and according to the knowledge assumed by the acceptance into the medical-health profession and subsequent professional refreshers; no responsibility can be attributed to Geass for damages of a nature that derive from such acts. The availability of technical-scientific information supporting the client, in fact, does not exonerate the user from the obligation to personally verify the suitability of the product to the purpose of the foreseen procedures. The user is obliged to continually update his knowledge on the development and the applications of the Geass implantological systems. Any use of the system different from the one given, is considered as 'improper use', exonerating the manufacturer from any obligation or responsibility. For uses not expressly foreseen or advised, the user must contact the manufacturer and obtain explicit authorization. The working, handling, and application of the product is performed outside of the manufacturer's control and therefore the responsibility falls to the user. For endoral application of medical devices, it is advisable to always adopt the necessary precautions (e.g. dental dam) in order to eliminate the risk of accidental inhalation.

#### 3. Guarantee

The manufacturer, within the terms and conditions of sale, guarantees that the

products do not have any defects. Geass recognizes a guarantee of twelve months from the delivery date of the product. Geass is obliged to substitute the quantity of products recognized as defective due to manufacture or origin. The guarantee is forfeit and any form of recompense from the manufacturer is excluded should there be improper product use, according to the cases listed in paragraph 1 (manufacturer responsibility) and 2 (user responsibility). Returns must be previously agreed on with the manufacturer and accompanied by the specific documentation. Information on the existence of patents, brand protection rights or other intangible goods is not legally binding.

#### 4. Documentation

The brochures and detailed instructions for use for the implantological Geass systems must be requested from our commercial representatives, area dealers or directly from the head office. Customer service: telephone: +39 0432 669191 – fax +39 0432 665323 e-mail: [servizioclienti@geass.it](mailto:servizioclienti@geass.it) website: [www.geass.it](http://www.geass.it) Information herein contained shows the state of the art at the moment of commercialization of the product. This does not exonerate the user from the responsibility of personally verifying that the product is suitable for the purposes and procedures foreseen.

#### 5. Seminars and educational course

Geass regularly organizes seminars and educational courses in order to allow users of their products to be informed and refresh their knowledge on the characteristics and on the suitable use of the Geass implant systems.

#### 6. Product identification

All Geass products are identifiable by the article and lot code shown on the accompanying label of the medical devices..

#### 7. Sales packaging

Unless otherwise indicated in the catalog, each product unit identified by the article code is sold in single packaging.

#### 8. Delivery and availability

Geass products are sold to Dentists and Dental laboratories, or for them, according to the relevant competences. Some components may not be available in some Countries or commercial areas.

#### 9. Copyright

Way is a registered brand.

#### 10. Note

For anything not shown in these warnings, see the technical specifications, conditions of use and instructions contained in the Geass informative materials.

#### Ordering method

1. On placing orders, always refer to the article code.

2. Orders that are received before 12.30 p.m. will be delivered by the end of the following day depending on entity, availability and particular zones. Sales conditions

1. These terms and conditions of sale are intended as accepted by the client on delivery of the order. Any variations, the stipulation of which are hereby illustrated, shall only be valid if accepted by Geass in writing.

2. Regarding market conditions, Geass

reserves the right to modify products, contents of catalogs and prices at any time and with no prior forewarning.

3. Freight charges are paid by the customer. Goods are shipped at the customer's risk even when delivered DAP destination.

4. The delivery terms may undergo variations. Any misunderstandings owing to shipping inefficiency cannot be attributed to Geass.

5. Geass reserves the right to carry out partial delivery.

6. The price list applied is the one valid at the time of the order. Payment of orders must be according to payment method and within the terms established. In the case of default, Geass reserves the right to vary the conditions of payment for subsequent supplies or to put into practice every effective or precautionary measure to totally recoup any outstanding credit.

7. Any complaints, relative to a lack of adherence to the terms and conditions of sale, must be communicated in writing to Geass Customer Service within 8 (eight) days of receiving the goods.

8. Geass srl offers you the possibility to substitute products purchased under the following conditions:

- product cost equal to or above (payment of any difference by client);
- within 12 months of the invoice date and within 6 months of the product going out of date

- date shown on label;

- residual product whole; original packaging complete and sealed;

- product accompanied by transport documentation and a copy of the purchase invoice;

- should these above mentioned conditions not be fulfilled, the product will not be considered suitable and will be returned to the sender and all shipping costs will be charged. Geass srl recognizes the right of withdrawal within 14 working days from the date of the delivery of the goods.

9. Geass declines any responsibility for any involuntary errors in the catalog and price lists.

10. For anything not expressly foreseen in the general terms and conditions of sale, Italian law will be applied. For any disputes, the Court of Udine (Italy) is the competent body.

#### Document validity

This document substitutes the previous edition.

It is absolutely forbidden to reproduce, even partially, these materials (text and illustrations) without written authorization from Geass S.r.l.



Geass srl

Via Madonna della Salute, 23  
33050 Pozzuolo del Friuli (UD) - I  
tel + 39 0432 669191 info@geass.it  
www.geass.it

